

Clamping elements and precision joints

CLAMPEX®

Types of clamping elements	318
Selection	320
Selection guide	322
Calculation of hubs	323
KTR 100	324
KTR 105	326
KTR 130 and KTR 131	328
KTR 150	330
KTR 200 and KTR 201	332
KTR 203 and KTR 206	334
KTR 225	336
KTR 250	338
KTR 400	340
KTR 603	342
KTR 620	346
KTR 700	350

KTR Clamping nuts

Large screw connections for easy and quick assembly	352
--	-----

KTR Precision joints

Series and selection criteria	354
Instructions for correct assembly	355
Selection and sizing	356
Type G and GD with plain bearing	358
Type H and HD with needle bearing	359
Type GA and HA plain and needle bearing (extendable)	360
Type X and XD with plain bearing made of stainless steel	361
Type GR and HR with quick locking	362
Accessories (protection bushings)	363

Internal clamping elements



External clamping elements



Shaft couplings

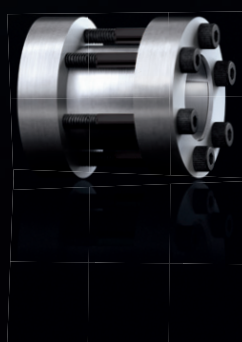

Precision joints



CLAMPEX® CLAMPING ELEMENTS TYPES AND OPERATING DESCRIPTION

Properties of clamping elements

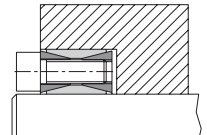
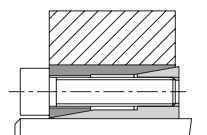
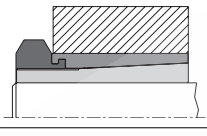
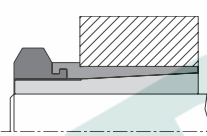
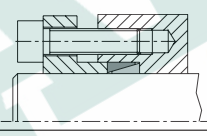
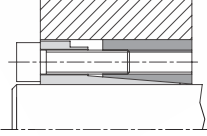
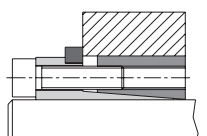
Type	Series	Shaft diameter [mm]	Transmittable torque T [Nm]	Centering of hub to shaft via the clamping element	Centering between hub and shaft required	Axial displacement of hub during assembly of clamping element	Details on page
Internal clamping elements	 KTR 100	17 – 1,000	260 – 3,017,100		●		324 325
	 KTR 105	5 – 50	5 – 1,900	●		●	326 327
	 KTR 130	5 – 50	10 – 2,320	●		●	328 329
	 KTR 131	5 – 35	10 – 836	●		●	328 329
	 KTR 150	6 – 440	2 – 215,000		●	●*	330 331
	 KTR 200	20 – 200	530 – 68,000	●		●	332 333
	 KTR 201	20 – 200	320 – 48,800	●			332 333

* Depending on mounting position

CLAMPEX® CLAMPING ELEMENTS

TYPES AND OPERATING DESCRIPTION

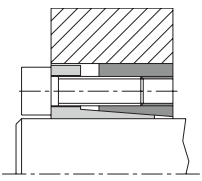
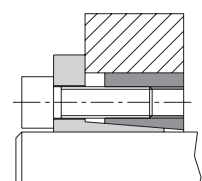
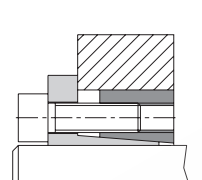
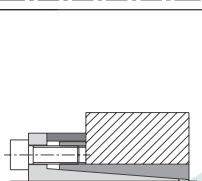
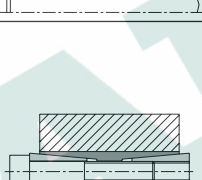
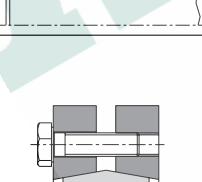
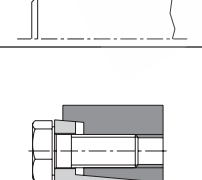
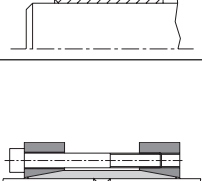
Type	Series	Shaft diameter [mm]	Transmittable torque T [Nm]	Centering of hub to shaft via the clamping element	Centering between hub and shaft required	Axial displacement of hub during assembly of clamping element	Details on page
Internal clamping elements	 KTR 203	18 – 400	370 – 487,000	●		●	334 335
	 KTR 206	18 – 400	290 – 342,000	●			334 335
	 KTR 225	14 – 50	287 – 1,796	●			336 337
	 KTR 250	6 – 130	11 – 25,000	●			338 339
	 KTR 400	24 – 600	700 – 1,640,000	●		●	340 341
External clamping elements	 KTR 603	10 – 420	28 – 1,460,000	●			342 - 345
	 KTR 620	13 – 700	70 – 7,394,000	●			346 - 349
Shaft couplings	 KTR 700	10 – 100	62 – 8,350	●			350 351

CLAMPEX®

Clamping nuts

KTR Precision joints

Clamping sets

Guide for selection

1. Which properties of a clamping set are required?

- Shall shaft and hub be centered to each other by the clamping set?
- Is axial displacement of the hub permissible during assembly of the clamping set?

For an explanation of the properties specified above see CLAMPEX® selection guide on page 322.

2. Which dimensions of clamping sets are required?

- Internal diameter of clamping set = shaft diameter
- External diameter of clamping set = diameter of hub bore
- Length of clamping set

For dimensions of clamping sets see catalogue on page 324 et seqq.

3. How much torque and/or axial force needs to be transmitted?

The following safety factors are recommended by KTR:

- ≥ 1.5 between the maximum torque of machine/axial force and the transmittable torque/axial force of clamping set.
- ≥ 2.0 between the rated torque of machine/axial force and the transmittable torque/axial force of clamping set.

4. Is the wall thickness of the hubs sufficient?

Calculation of wall thickness of the hubs is possible via the following methods:

- For formula for calculating the necessary outside diameter of hubs see page 321.
- For calculating the necessary outside diameter of hub via correction factor see page 323.

5. Other selection criteria

Please consult with KTR.

- The clamping set is to be mounted on a shaft with a feather keyway.
- Simultaneous transmission of torque and axial force.
- The clamping set is radially loaded.
- The clamping set is stressed on bending.
- High circumferential speeds (from 30 m/s).
- High operating temperatures.
- Shaft with bore (hollow shaft).
- Clamping set in a corrosion-protected design.

Selection

Use in potentially explosive atmospheres

The power transmission of CLAMPEX® clamping elements is based on the principle of two taper rings twisted into each other. Axial force generated on the rings (by means of several screws) produces surface pressure inside the shaft and outside the hub which allows for frictionally engaged transmission of the torque. Considering all operating data (intended use), there is no potential source of ignition. That is why clamping elements do not come within the scope of directive 2014/34/EU.

Due to the aforementioned design of CLAMPEX® clamping elements a failure of components does not have to be anticipated. A risk only arises if friction heat is generated with slipping of a clamping connection (improper assembly/tightening torques).

Concentricity

The concentricity of the self-centering CLAMPEX® clamping elements is between 0.05 mm and 0.08 mm. This concentricity is not reproducible due to the slotted individual components of the clamping elements. As a result this figure merely serves for supporting with designing.

Table of screws						
Dimension M	Preload force F_V and tightening torque T_A with $\mu_{total} = 0.14$					
	Preload force F_V [N]			Tightening torque T_A [Nm]		
	8.8	10.9	12.9	8.8	10.9	12.9
M3	2210	3110	3730	1.34	1.89	2.25
M4	3900	5450	6550	2.9	4.1	4.9
M5	6350	8950	10700	6	8.5	10
M6	9000	12600	15100	10	14	17
M8	16500	23200	27900	25	35	41
M10	26200	36900	44300	49	69	83
M12	38300	54000	64500	86	120	145
M14	52500	74000	88500	135	190	230
M16	73000	102000	123000	210	295	355
M18	88000	124000	148000	290	405	485
M20	114000	160000	192000	410	580	690
M22	141000	199000	239000	550	780	930
M24	164000	230000	276000	710	1000	1200
M27	215000	302000	363000	1050	1500	1800
M30	262000	368000	442000	1450	2000	2400

Selection

Symbol	Definition resp. explanation
$\sigma_{N0.2}$	Yield point of hub material [N/mm ²]
$\sigma_{W0.2}$	Yield point of shaft material [N/mm ²]
C	Specific heat capacity C of hub type (see illustration on page 323)
d	Internal diameter of clamping element [mm]
d_{iW}	Internal diameter of hollow shaft [mm]
D	External diameter of clamping element [mm]
D_N	Required external diameter of hub [mm]
T	Transmittable torque [Nm]
T_S	Peak torque to be transmitted [Nm]
T_A	Screw tightening torque [Nm]
B2/B3	Length of clamping element [mm]

Symbol	Definition resp. explanation
L/L ₁	Hub length [mm]
P_N	Surface pressure generated on the clamping element/hub [N/mm ²]
P_W	Surface pressure generated on the clamping element/shaft [N/mm ²]
C _W	d_{iW}/d -> Ratio of internal diameter of hollow shaft/clamping element
C_N	D/D_N -> Ratio of external diameter of clamping element/hub
F_a	Axial force generated during operation [kN]
F_{ax}	Transmittable axial force [kN]
F_V	Preload force [N]
P_O	Setting force for clamping element [N]
P_S	Clamping force for clamping element [N]
P_A	$P_O + P_S$ = Total force for clamping element [N]

The transmission data are parameters found out by calculations. Subject to the friction coefficient variation which is subjected to physical properties, small deviations with the transmission figures may arise.

1. Fatigue strength and shape stability of components subjected to torsion and bending load

The stress concentration figures β_k for the clamping elements press fits are worked out similarly to those of pressure oil fits. Stress concentration factors on request.

2. Transmittable torque T

The transmittable torque T always has to be above the biggest torque peak T_S , which may arise on the joints. The torque peaks occurring with acceleration of electric motors as well as additional axial forces F_a have to be considered.

$$T \geq \sqrt{T_S^2 + (F_a \cdot \frac{d}{2})^2}$$

3. Transmittable axial force F_{ax}

The maximum transmittable axial force F_{ax} specified in the tables has to be reduced accordingly with additional torque transmission.

$$F_{ax} [kN] = 2 \cdot \frac{T [Nm]}{d [mm]}$$

4. Calculation of external diameter of hub D_N

The required external diameter of hub D_N depends on the hub geometry, the yield point of the hub material and the surface pressure between clamping element and hub. In order to simplify the calculation, the table on page 323 specifies correction values which allow to calculate D_N .

$$D_N [mm] \geq D \cdot \text{correction value } x$$

Those external diameters of hubs which cannot be calculated based on the table are calculated via the following formula:

$$D_N \geq D \cdot \sqrt{\frac{\sigma_{N0.2} + P_N \cdot C}{\sigma_{N0.2} - P_N \cdot C}}$$

Tangential stress on the internal diameter of hub

$$\sigma_{tiN} \approx P_N \cdot \frac{(1 + C_N)}{(1 - C_N^2)} \cdot C$$

For clamping connections with hollow shafts the required internal diameter of the hollow shaft d_{iW} is calculated based on the following formula:

Tangential stress on the internal diameter of shaft

$$\sigma_{tiW} \approx \frac{2 \cdot P_W}{(C_W^2 - 1)}$$

$$d_{iW} \leq d \cdot \sqrt{\frac{\sigma_{W0.2} - 2 \cdot P_W \cdot 0.8}{\sigma_{W0.2}}}$$

Selection of hub material with external clamping sets KTR 603 and KTR 620

The hub material should have a yield strength R_e of ≥ 350 N/mm². For applications with additional bending load, Q + T steel such as 42CrMo4 should be used.

Selection guide

Selection guide for CLAMPEX® clamping elements

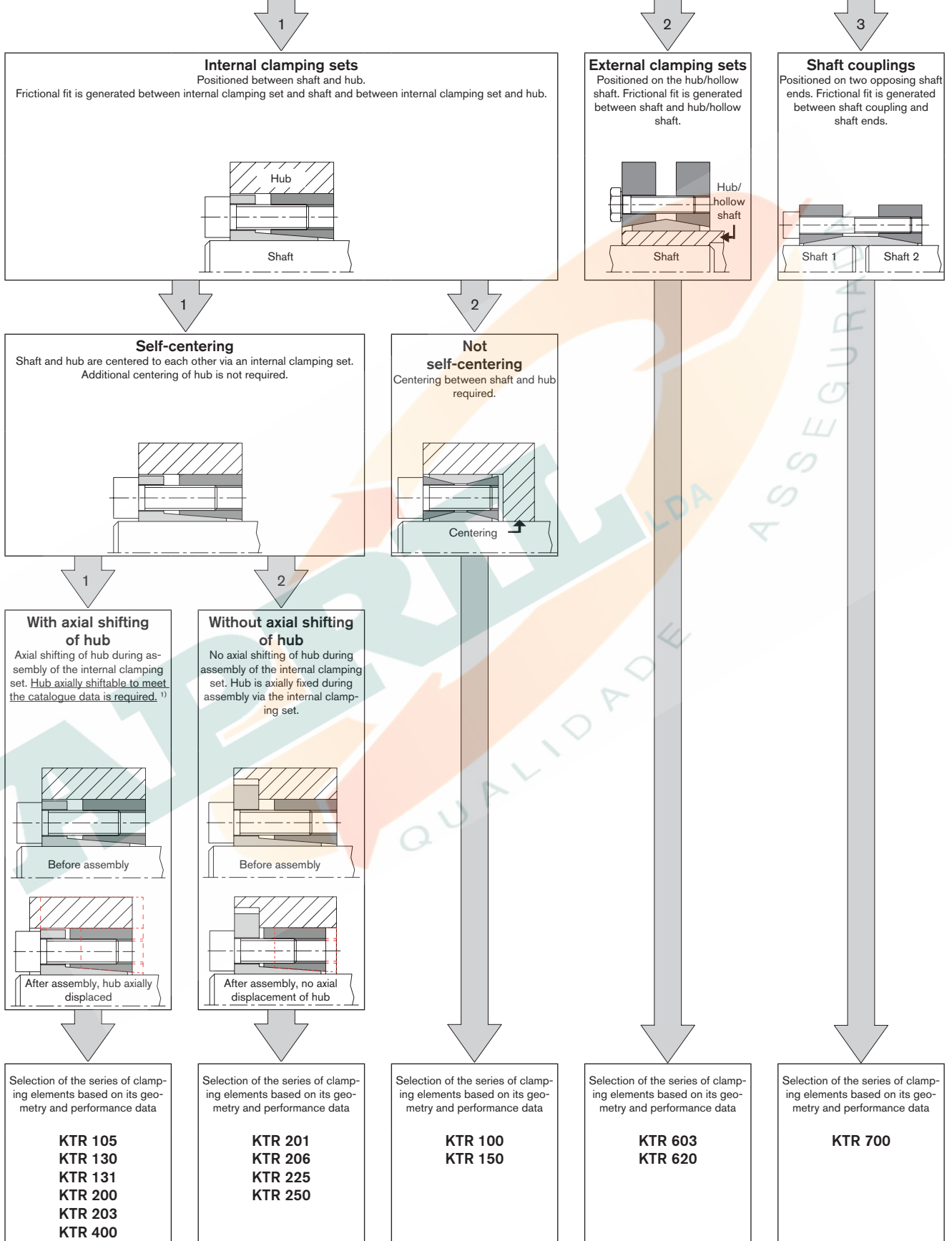

¹⁾ Does not apply for KTR 400

Calculation of hubs

Mounting conditions of clamping elements with specific heat capacity C of hub type

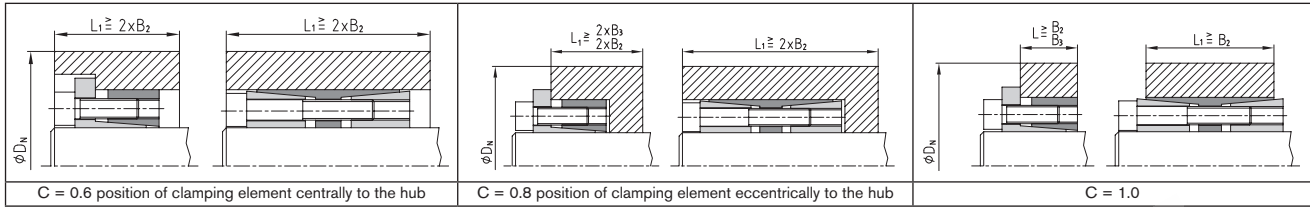

C = 0.6 position of clamping element centrally to the hub

C = 0.8 position of clamping element eccentrically to the hub

C = 1.0

Selection table for the calculation of the external diameter of hub D_h required (correction value x)

Surface pressure between clamping element and hub		Average yield point of material $\sigma \geq 0.2$ in N/mm ² (more accurate stiffness figures depending on diameter as specified by the manufacturer)										
		150	180	200	220	250	270	300	350	400	450	600
PN [N/mm ²]	Specific heat capacity C of hub type	Hub materials										
		GJL 200	GJL 250 GE 200	GJL 300 GJMB-350	GE 240	GJS 400-15 GE 260 AW-2007	E295 C 35	GJS 500-7 GE 300 S355J2	GJS 600-3 C 45	GJS 700-2 C 60	Q & T steel	Q & T steel
65	C = 0.6	1.30	1.25	1.22	1.20	1.18	1.15	1.13	1.11	1.10	1.09	1.07
	C = 0.8	1.44	1.35	1.30	1.28	1.24	1.22	1.20	1.16	1.14	1.12	1.09
	C = 1.0	1.60	1.45	1.40	1.35	1.30	1.28	1.24	1.20	1.18	1.16	1.12
70	C = 0.6	1.34	1.26	1.24	1.22	1.18	1.16	1.15	1.12	1.11	1.10	1.07
	C = 0.8	1.48	1.38	1.34	1.30	1.25	1.23	1.20	1.18	1.15	1.13	1.10
	C = 1.0	1.65	1.50	1.45	1.40	1.34	1.30	1.26	1.22	1.20	1.17	1.13
75	C = 0.6	1.30	1.28	1.25	1.23	1.20	1.18	1.16	1.14	1.12	1.11	1.08
	C = 0.8	1.52	1.42	1.36	1.32	1.28	1.25	1.22	1.18	1.16	1.14	1.11
	C = 1.0	1.74	1.55	1.48	1.42	1.36	1.33	1.30	1.25	1.20	1.18	1.13
80	C = 0.6	1.39	1.31	1.28	1.25	1.21	1.20	1.18	1.15	1.13	1.11	1.08
	C = 0.8	1.58	1.45	1.39	1.35	1.30	1.27	1.24	1.20	1.18	1.15	1.11
	C = 1.0	1.81	1.61	1.53	1.46	1.39	1.36	1.31	1.26	1.22	1.20	1.14
85	C = 0.6	1.42	1.34	1.30	1.27	1.23	1.21	1.19	1.16	1.14	1.12	1.09
	C = 0.8	1.63	1.49	1.42	1.38	1.32	1.29	1.26	1.22	1.19	1.16	1.12
	C = 1.0	1.90	1.67	1.57	1.50	1.42	1.39	1.34	1.28	1.24	1.21	1.15
90	C = 0.6	1.46	1.36	1.32	1.28	1.25	1.22	1.20	1.17	1.15	1.13	1.09
	C = 0.8	1.69	1.53	1.46	1.40	1.34	1.31	1.28	1.23	1.20	1.18	1.13
	C = 1.0	2.00	1.73	1.62	1.54	1.46	1.41	1.36	1.30	1.26	1.22	1.16
95	C = 0.6	1.49	1.39	1.34	1.30	1.26	1.24	1.21	1.18	1.15	1.14	1.10
	C = 0.8	1.75	1.57	1.49	1.43	1.37	1.34	1.30	1.25	1.21	1.19	1.14
	C = 1.0	2.11	1.80	1.68	1.59	1.49	1.44	1.39	1.32	1.27	1.24	1.17
100	C = 0.6	1.53	1.41	1.36	1.32	1.28	1.25	1.22	1.19	1.16	1.14	1.11
	C = 0.8	1.81	1.61	1.53	1.46	1.39	1.36	1.31	1.26	1.22	1.20	1.14
	C = 1.0	2.24	1.87	1.73	1.63	1.53	1.48	1.41	1.34	1.29	1.25	1.18
105	C = 0.6	1.56	1.44	1.39	1.34	1.29	1.27	1.24	1.20	1.17	1.15	1.11
	C = 0.8	1.88	1.66	1.56	1.50	1.42	1.38	1.33	1.28	1.24	1.21	1.15
	C = 1.0	2.38	1.95	1.79	1.68	1.56	1.51	1.44	1.36	1.31	1.27	1.19
110	C = 0.6	1.60	1.47	1.41	1.36	1.31	1.28	1.25	1.21	1.18	1.16	1.12
	C = 0.8	1.96	1.71	1.60	1.53	1.44	1.40	1.35	1.29	1.25	1.22	1.16
	C = 1.0	2.55	2.04	1.86	1.73	1.60	1.54	1.47	1.38	1.33	1.28	1.20
115	C = 0.6	1.64	1.50	1.43	1.36	1.33	1.30	1.26	1.22	1.19	1.17	1.12
	C = 0.8	2.04	1.76	1.64	1.56	1.47	1.43	1.37	1.31	1.26	1.23	1.17
	C = 1.0	2.75	2.13	1.93	1.79	1.64	1.58	1.50	1.41	1.34	1.30	1.21
120	C = 0.6	1.69	1.53	1.46	1.40	1.34	1.31	1.28	1.23	1.20	1.18	1.13
	C = 0.8	2.13	1.81	1.69	1.60	1.50	1.45	1.39	1.33	1.28	1.24	1.18
	C = 1.0	3.00	2.24	2.00	1.84	1.69	1.61	1.53	1.43	1.36	1.31	1.22
125	C = 0.6	1.73	1.56	1.48	1.43	1.36	1.33	1.29	1.24	1.21	1.18	1.13
	C = 0.8	2.24	1.87	1.73	1.63	1.53	1.48	1.41	1.34	1.29	1.25	1.18
	C = 1.0	3.32	2.35	2.08	1.91	1.73	1.65	1.56	1.45	1.38	1.33	1.24
130	C = 0.6	1.78	1.59	1.51	1.45	1.38	1.35	1.30	1.25	1.22	1.19	1.14
	C = 0.8	2.35	1.93	1.78	1.67	1.56	1.50	1.44	1.36	1.30	1.27	1.19
	C = 1.0	3.74	2.49	2.17	1.97	1.78	1.69	1.59	1.48	1.40	1.35	1.25
135	C = 0.6	1.83	1.62	1.54	1.47	1.40	1.36	1.32	1.27	1.23	1.20	1.15
	C = 0.8	2.48	2.00	1.83	1.71	1.59	1.53	1.46	1.38	1.32	1.28	1.20
	C = 1.0	4.36	2.65	2.27	2.04	1.83	1.73	1.62	1.50	1.42	1.36	1.26
140	C = 0.6	1.88	1.66	1.56	1.50	1.42	1.38	1.33	1.28	1.24	1.21	1.15
	C = 0.8	2.63	2.07	1.88	1.75	1.62	1.55	1.48	1.39	1.33	1.29	1.21
	C = 1.0	5.39	2.83	2.38	2.12	1.88	1.78	1.66	1.53	1.44	1.38	1.27
145	C = 0.6	1.94	1.69	1.59	1.52	1.44	1.40	1.35	1.29	1.25	1.22	1.16
	C = 0.8	2.80	2.15	1.94	1.80	1.65	1.58	1.50	1.41	1.35	1.30	1.22
	C = 1.0	7.68	3.05	2.50	2.21	1.94	1.82	1.69	1.55	1.46	1.40	1.28
150	C = 0.6	2.00	1.73	1.62	1.54	1.46	1.41	1.36	1.30	1.26	1.23	1.16
	C = 0.8	3.00	2.24	2.0	1.84	1.69	1.61	1.53	1.43	1.36	1.31	1.23
	C = 1.0	-	3.32	2.65	2.30	2.00	1.87	1.73	1.58	1.48	1.41	1.29
155	C = 0.6	2.06	1.77	1.65	1.57	1.48	1.43	1.38	1.31	1.27	1.24	1.17
	C = 0.8	3.25	2.33	2.06	1.89	1.72	1.65	1.55	1.45	1.38	1.33	1.23
	C = 1.0	-	3.66	2.80	2.40	2.06	1.92	1.77	1.61	1.51	1.43	1.30
160	C = 0.6	2.13	1.81	1.69	1.60	1.50	1.45	1.39	1.33	1.28	1.24	1.18
	C = 0.8	3.55	2.43	2.13	1.94	1.76	1.67	1.58	1.47	1.39	1.34	1.24
	C = 1.0	-	4.12	3.00	2.52	2.13	1.98	1.81	1.64	1.53	1.45	1.31
165	C = 0.6	2.21	1.86	1.72	1.62	1.52	1.47	1.41	1.34	1.29	1.25	1.18
	C = 0.8	3.96	2.55	2.21	2.00	1.80	1.71	1.60	1.49	1.41	1.35	1.25
	C = 1.0	-	4.80	3.23	2.65	2.21	2.04	1.86	1.67	1.55	1.47	1.33

CLAMPEX® KTR 100

Clamping elements

Not self-centering, suitable for large shaft and hub tolerances

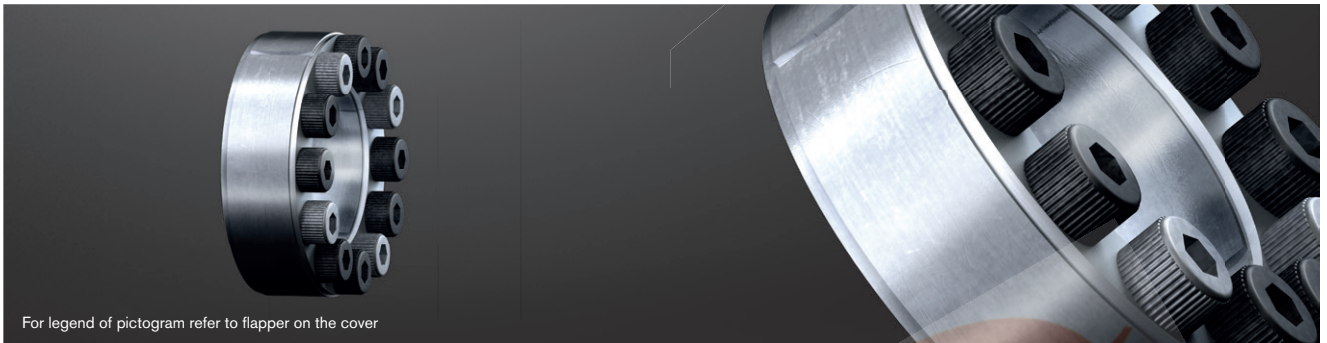

For legend of pictogram refer to flapper on the cover

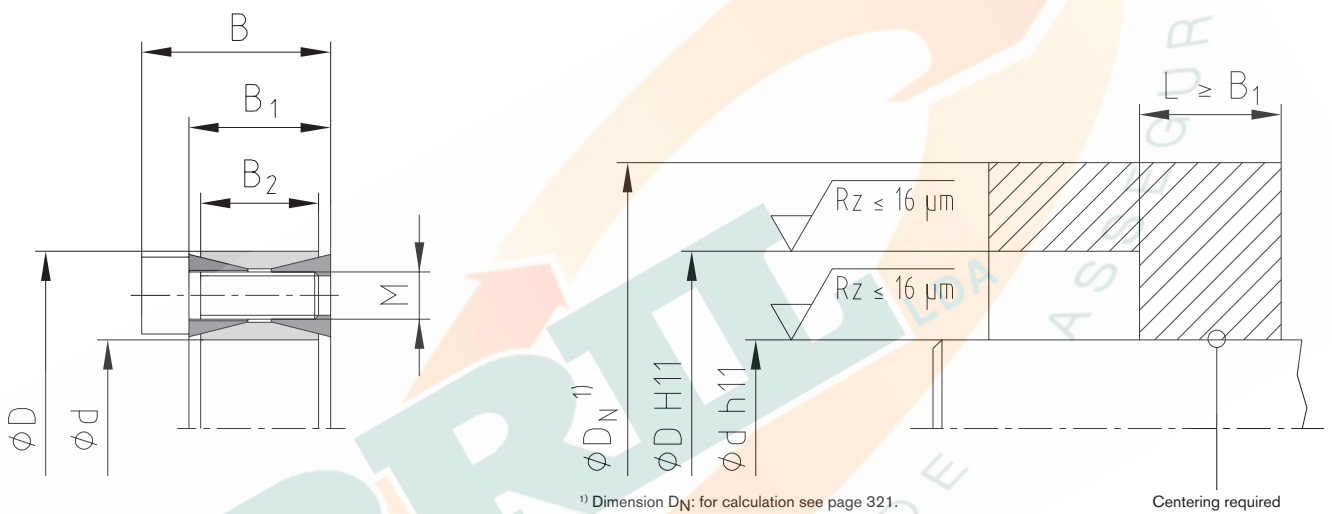

Example of application of hub type

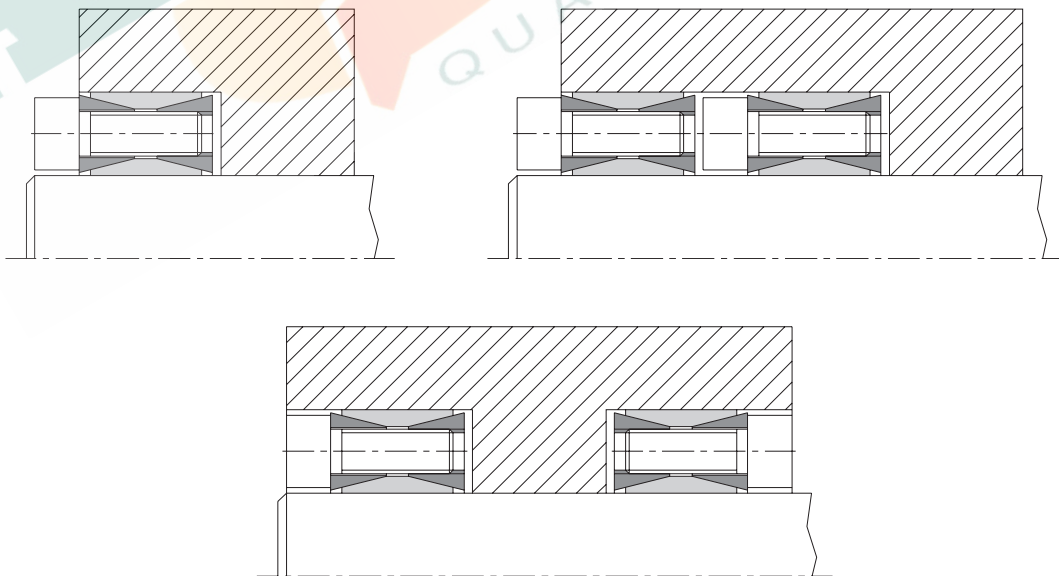

● Sizes of clamping elements available from stock.

¹⁾ These are the maximum screw tightening torques. They can be reduced by a maximum of 40 % of the above-mentioned figures with T, F_{ax} , P_W and P_N decreasing proportionately.

Ordering example:	KTR 100	50	x	80
	Series	Size of internal diameter d		Size of external diameter D

CLAMPEX® – KTR 100

d x D [mm]	Dimensions [mm]			Clamping screws DIN EN ISO 4762 - 12.9 $\mu_{total}=0.14$				Transmittable torque or axial force			Surface pressure between clamping element		Weight [-kg]	Stock programme
	B	B ₁	B ₂	M	Length	z = number	T _A [Nm] ¹⁾	T [Nm]	F _{ax} [kN]	Shaft P _W [N/mm ²]	Hub P _N [N/mm ²]			
17 x 47	26	20	17	M6	18	8	16	260	31	281	102	0.2		
18 x 47	26	20	17	M6	18	8	16	280	31	270	103	0.2		
19 x 47	26	20	17	M6	18	8	16	290	31	251	101	0.2	●	
20 x 47	26	20	17	M6	18	8	16	310	31	242	103	0.2	●	
22 x 47	26	20	17	M6	18	8	16	340	31	219	103	0.2	●	
24 x 50	26	20	17	M6	18	8	16	370	31	200	96	0.3	●	
25 x 50	26	20	17	M6	18	8	16	390	31	195	97	0.3	●	
28 x 55	26	20	17	M6	18	12	16	650	46	259	132	0.3	●	
30 x 55	26	20	17	M6	18	12	16	700	47	243	132	0.3	●	
32 x 60	26	20	17	M6	18	12	16	750	47	229	122	0.3	●	
35 x 60	26	20	17	M6	18	12	16	820	47	209	122	0.3	●	
38 x 65	26	20	17	M6	18	15	16	1100	58	238	139	0.4	●	
40 x 65	26	20	17	M6	18	15	16	1170	59	228	140	0.3	●	
42 x 75	32	24	20	M8	22	12	40	1670	80	251	141	0.6	●	
45 x 75	32	24	20	M8	22	12	40	1790	80	234	141	0.5	●	
48 x 80	32	24	20	M8	22	12	40	1900	79	219	131	0.6	●	
50 x 80	32	24	20	M8	22	12	40	1990	80	211	132	0.6	●	
55 x 85	32	24	20	M8	22	15	40	2740	100	240	155	0.6	●	
60 x 90	32	24	20	M8	22	15	40	2990	100	220	147	0.7	●	
65 x 95	32	24	20	M8	22	15	40	3240	100	203	139	0.8	●	
70 x 110	38	28	24	M10	25	15	78	5550	159	250	159	1.3	●	
75 x 115	38	28	24	M10	25	15	78	5950	159	234	152	1.2	●	
80 x 120	38	28	24	M10	25	15	78	6350	159	219	146	1.4	●	
85 x 125	38	28	24	M10	25	15	78	6740	159	206	140	1.4	●	
90 x 130	38	28	24	M10	25	15	78	7140	159	195	135	1.5	●	
95 x 135	38	28	24	M10	25	18	78	9000	189	220	155	1.6	●	
100 x 145	44	32	26	M12	30	15	135	11600	232	237	163	2.2	●	
110 x 155	44	32	26	M12	30	15	135	12750	232	215	153	2.3	●	
120 x 165	44	32	26	M12	30	16	135	14800	247	210	153	2.4	●	
130 x 180	50	38	34	M12	30	20	135	20150	310	186	134	3.5	●	
140 x 190	50	38	34	M12	30	22	135	23850	341	190	140	3.8	●	
150 x 200	50	38	34	M12	30	24	135	27850	371	193	145	4.0	●	
160 x 210	50	38	34	M12	30	26	135	32200	403	196	150	4.4	●	
170 x 225	58	44	38	M14	45	22	215	40300	474	195	147	5.7	●	
180 x 235	58	44	38	M14	45	24	215	46600	518	201	154	6.0	●	
190 x 250	66	52	46	M14	45	28	215	57300	603	183	139	8.0	●	
200 x 260	66	52	46	M14	45	30	215	71000	710	205	157	8.2	●	
220 x 285	72	56	50	M16	50	26	335	93200	847	204	158	11.0	●	
240 x 305	72	56	50	M16	50	30	335	117300	978	216	170	12.2	●	
260 x 325	72	56	50	M16	50	34	335	144000	1108	226	181	13.2	●	
280 x 355	84	66	60	M18	60	32	465	177700	1269	200	158	19.2	●	
300 x 375	84	66	60	M18	60	36	465	214100	1427	210	168	20.5	●	
320 x 405	98	78	72	M20	70	36	660	295800	1849	213	168	29.6	●	
340 x 425	98	78	72	M20	70	36	660	314300	1849	200	160	31.1	●	
360 x 455	112	90	84	M22	80	36	900	413300	2296	201	159	42.2	●	
380 x 475	112	90	84	M22	80	36	900	436300	2296	191	153	44.0	●	
400 x 495	112	90	84	M22	80	36	900	459300	2297	181	147	46.0	●	
420 x 515	112	90	84	M22	80	40	900	535800	2551	192	156	50.0	●	
440 x 545	130	102	96	M24	90	40	1130	647600	2944	185	149	64.6	●	
460 x 565	130	102	96	M24	90	40	1130	677000	2943	177	144	67.4	●	
480 x 585	130	102	96	M24	90	42	1130	741800	3091	178	146	71.0	●	
500 x 605	130	102	96	M24	90	44	1130	809500	3238	179	148	72.6	●	
520 x 630	130	102	96	M24	90	45	1130	861000	3312	176	145	80	●	
540 x 650	130	102	96	M24	90	45	1130	894000	3311	169	141	82	●	
560 x 670	130	102	96	M24	90	48	1130	989000	3532	174	146	85	●	
580 x 690	130	102	96	M24	90	50	1130	1067000	3679	175	147	88	●	
600 x 710	130	102	96	M24	90	50	1130	1103800	3679	169	143	91	●	
620 x 730	130	102	96	M24	90	52	1130	1186200	3826	171	145	93	●	
640 x 750	130	102	96	M24	90	54	1130	1271600	3974	172	146	96	●	
660 x 770	130	102	96	M24	90	56	1130	1359900	4121	173	148	99	●	
680 x 790	130	102	96	M24	90	56	1130	1401100	4121	167	144	102	●	
700 x 810	130	102	96	M24	90	60	1130	1545400	4415	174	151	104	●	
720 x 830	130	102	96	M24	90	60	1130	1589500	4415	169	147	107	●	
740 x 850	130	102	96	M24	90	62	1130	1688100	4562	170	148	110	●	
760 x 870	130	102	96	M24	90	64	1130	1789700	4710	171	150	113	●	
780 x 890	130	102	96	M24	90	65	1130	1865500	4783	169	149	116	●	
800 x 910	130	102	96	M24	90	66	1130	1942700	4857	168	147	118	●	
820 x 930	130	102	96	M24	90	68	1130	2051600	5004	169	149	121	●	
840 x 950	130	102	96	M24	90	70	1130	2163500	5151	169	150	124	●	
860 x 970	130	102	96	M24	90	72	1130	2278300	5298	170	151	127	●	
880 x 990	130	102	96	M24	90	74	1130	2396000	5445	171	152	129	●	
900 x 1010	130	102	96	M24	90	75	1130	2483600	5519	169	151	132	●	
920 x 1030	130	102	96	M24	90	76	1130	2572600	5593	168	150	135	●	
940 x 1050	130	102	96	M24	90	78	1130	2697700	5740	169	151	138	●	
960 x 1070	130	102	96	M24	90	80	1130	2825800	5887	169	152	140	●	
980 x 1090	130	102	96	M24	90	81	1130	2920700	5961	168	151	143	●	
1000 x 1110	130	102	96	M24	90	82	1130	3017100	6034	167	150	146	●	

CLAMPEX®

Clamping nuts

KTR Precision joints

Clamping sets

CLAMPEX® KTR 105

Clamping elements

Self-centering clamping element in a compact design

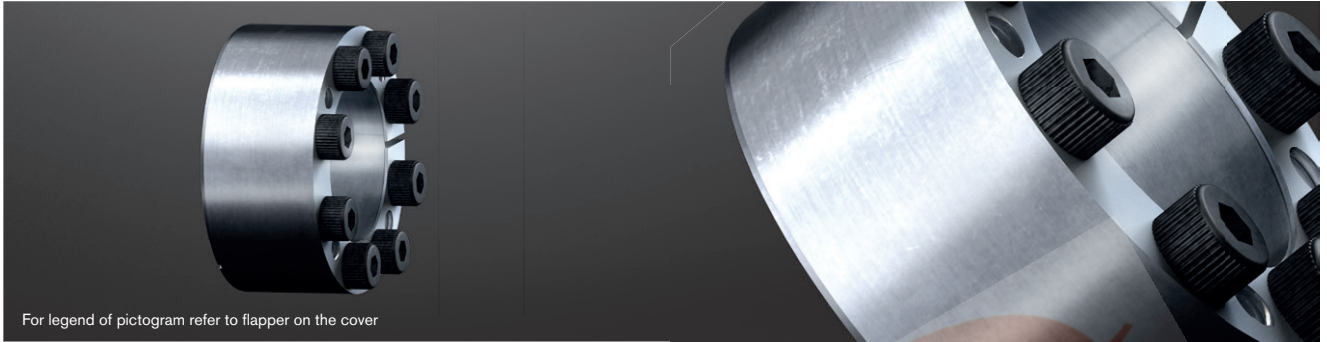

For legend of pictogram refer to flapper on the cover

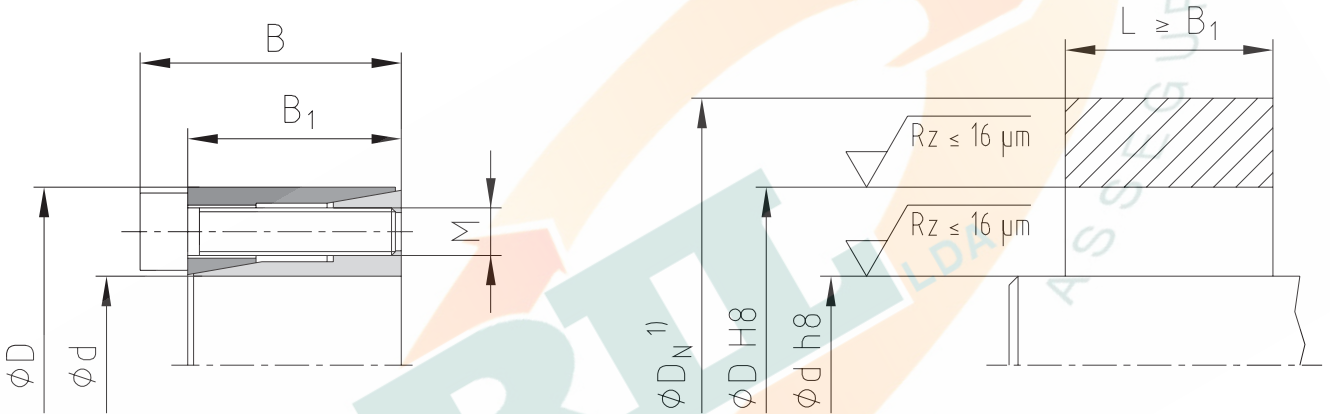
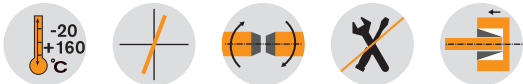

¹⁾ Dimension D_N : for calculation see page 321.

Example of application of hub type

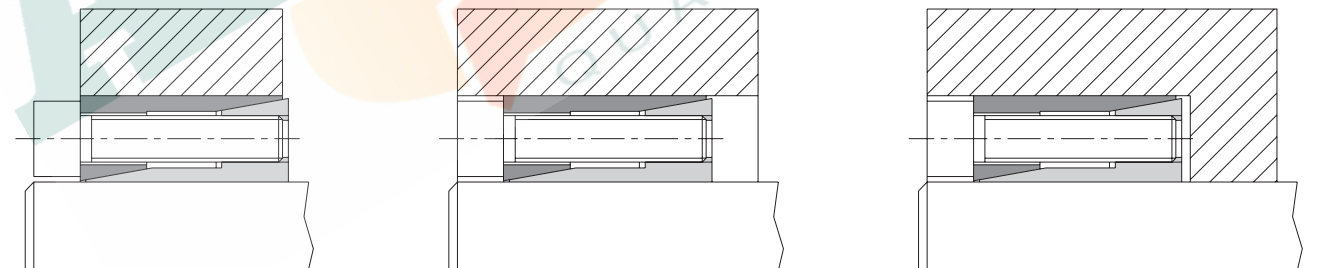

Ordering example:

KTR 105	8	x	18
Series	Size of internal diameter d		Size of external diameter D

CLAMPEX® – KTR 105													
d x D [mm]	Dimensions [mm]		Clamping screws DIN EN ISO 4762 - 12.9 $\mu_{total}=0.14$				Transmittable torque or axial force			Surface pressure between clamping element		Weight [-kg]	Stock programme
	B	B1	M	Length	z = number	T _A [Nm] ¹⁾	T [Nm]	F _{ax} [kN]	Shaft P _W [N/mm ²]	Hub P _N [N/mm ²]			
5 x 16	13.5	11	M2.5	10	3	1.2	5	2	177	55	0.01	●	
6 x 16	13.5	11	M2.5	10	3	1.2	6	2	147	55	0.01	●	
6.35 x 16	13.5	11	M2.5	10	3	1.2	6	2	132	52	0.01	●	
7 x 17	13.5	11	M2.5	10	3	1.2	8	2	144	59	0.01	●	
8 x 18	13.5	11	M2.5	10	3	1.2	10	3	138	61	0.02	●	
9 x 20	15.5	13	M2.5	12	4	1.2	15	3	140	63	0.02	●	
9.53 x 20	15.5	13	M2.5	12	4	1.2	15	3	125	60	0.02	●	
10 x 20	15.5	13	M2.5	12	4	1.2	15	3	114	57	0.02	●	
11 x 22	15.5	13	M2.5	12	4	1.2	18	3	113	56	0.02	●	
12 x 22	15.5	13	M2.5	12	4	1.2	20	3	105	57	0.02	●	
14 x 26	20	17	M3	16	4	2.1	35	5	105	57	0.04	●	
15 x 28	20	17	M3	16	4	2.1	40	5	94	51	0.04	●	
16 x 32	21	17	M4	16	4	4.9	70	9	132	66	0.07	●	
17 x 35	25	21	M4	20	4	4.9	75	9	125	61	0.09	●	
18 x 35	25	21	M4	20	4	4.9	80	9	119	61	0.09	●	
19 x 35	25	21	M4	20	4	4.9	85	9	114	62	0.08	●	
20 x 38	26	21	M5	20	4	9.7	150	15	153	81	0.1	●	
22 x 40	26	21	M5	20	4	9.7	160	15	135	74	0.1	●	
24 x 47	32	26	M6	25	4	16.5	250	21	154	78	0.2	●	
25 x 47	32	26	M6	25	4	16.5	260	21	147	78	0.2	●	
28 x 50	32	26	M6	25	6	16.5	440	31	198	111	0.2	●	
30 x 55	32	26	M6	25	6	16.5	470	31	185	101	0.3	●	
32 x 55	32	26	M6	25	6	16.5	500	31	173	100	0.25	●	
35 x 60	37	31	M6	30	8	16.5	730	42	166	97	0.35	●	
38 x 65	37	31	M6	30	8	16.5	800	42	155	90	0.4	●	
40 x 65	37	31	M6	30	8	16.5	840	42	147	90	0.4	●	
42 x 75	44	36	M8	35	6	40	911	43	125	70	0.7	●	
45 x 75	44	36	M8	35	8	40	1300	58	155	93	0.6	●	
48 x 80	44	36	M8	35	8	40	1824	76	191	115	0.7	●	
50 x 80	44	36	M8	35	8	40	1900	76	183	115	0.7	●	

● Sizes of clamping elements available from stock.

¹⁾ These are the maximum screw tightening torques. They can be reduced by a maximum of 40 % of the above-mentioned figures with T, F_{ax}, P_W and P_N decreasing proportionately.

CLAMPEX® KTR 130 and KTR 131

Clamping elements

Self-centering clamping elements with a central clamping nut for easy assembly/disassembly

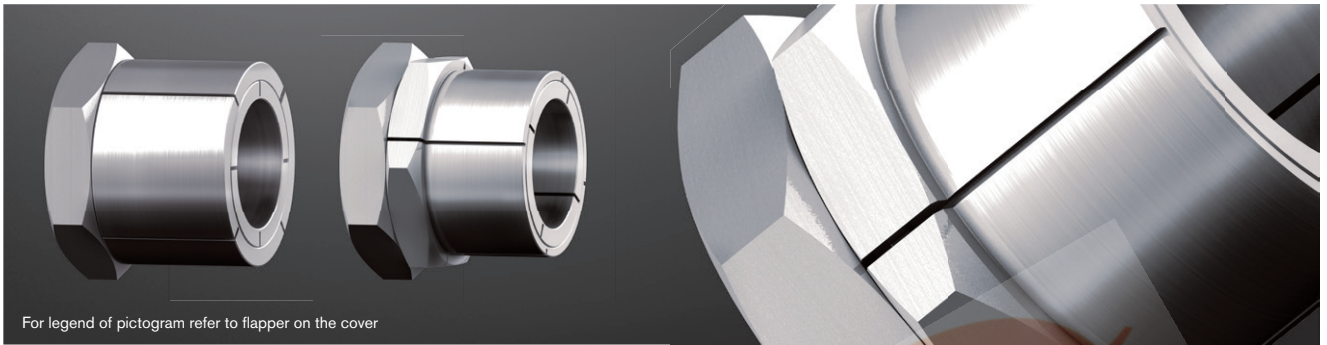

For legend of pictogram refer to flapper on the cover

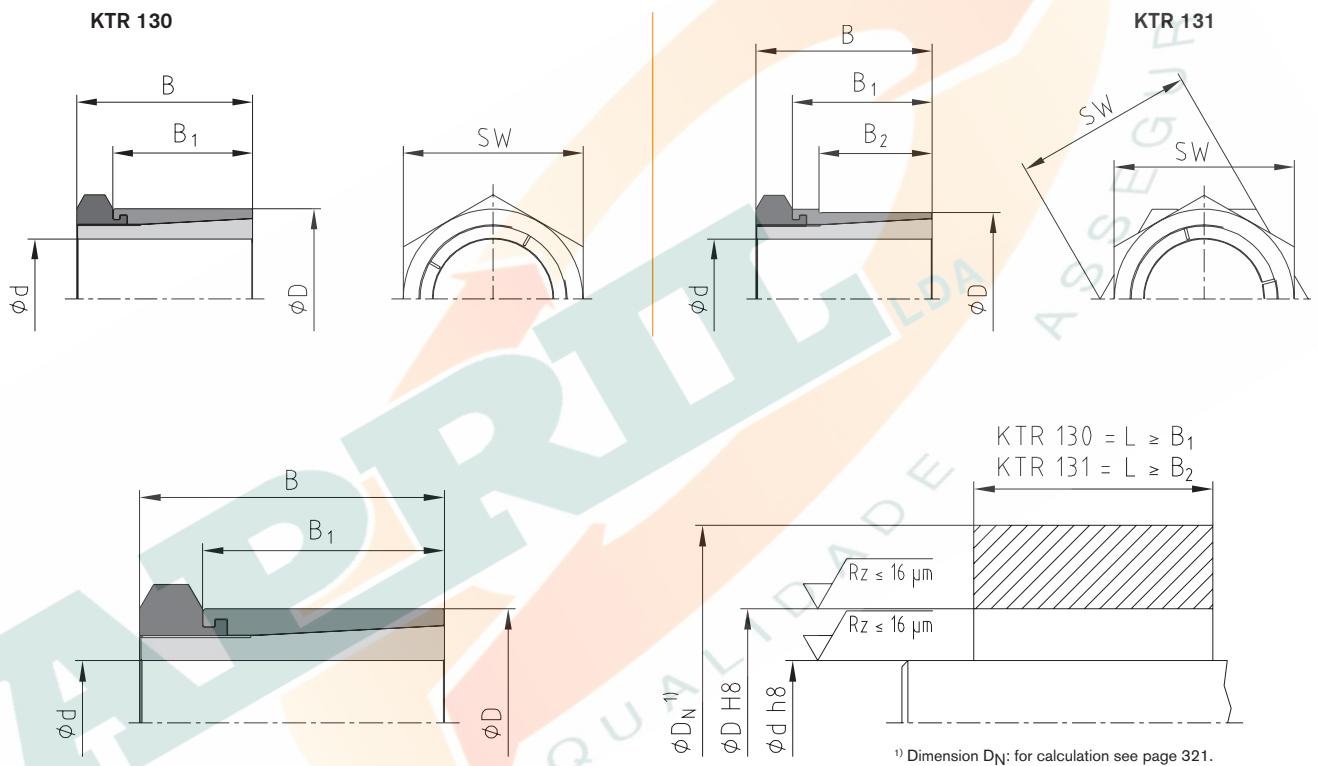

Example of application of hub type

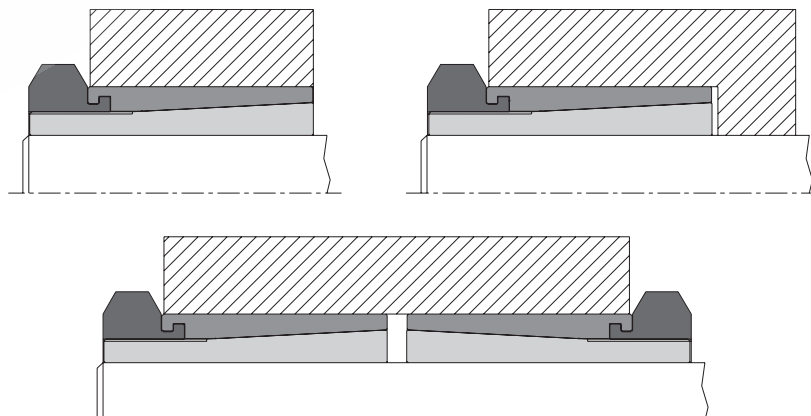

Ordering example:	KTR 130	18	x	35
	Series	Size of internal diameter d		Size of external diameter D

CLAMPEX® – KTR 130											
d x D [mm]	Dimensions [mm]		Hexagon nut		Transmittable torque or axial force			Surface pressure between clamping element		Weight [-kg]	Stock programme
	B	B ₁	Width across flats SW	T _A [Nm] ¹⁾	T [Nm]	F _{ax} [kN]	Shaft P _W [N/mm ²]	Hub P _N [N/mm ²]			
5 x 14	19	15	14	10	10.1	4.0	264	96	0.02	●	
6 x 14	19	15	14	10	12.1	4.0	220	96	0.02	●	
8 x 16	22	17	17	17	23.4	5.8	179	91	0.02	●	
9 x 20	24	19	22	35	43.2	9.7	248	112	0.04	●	
10 x 20	24	19	22	35	48.6	9.7	223	112	0.05	●	
12 x 22	24	19	22	44	65.3	10.9	206	117	0.05	●	
14 x 26	28	22	27	65	93.0	13.3	178	99	0.08	●	
15 x 26	28	22	27	65	99.0	13.3	166	99	0.08	●	
16 x 26	28	22	27	65	106	13.3	156	99	0.07	●	
18 x 35	36	27	36	161	223	24.8	224	125	0.2	●	
19 x 35	36	27	36	161	235	24.8	212	125	0.2	●	
20 x 35	36	27	36	161	248	24.8	201	125	0.2	●	
22 x 42	41	30	46	250	349	31.8	197	110	0.3	●	
24 x 42	41	30	46	250	381	31.8	180	110	0.3	●	
25 x 42	41	30	46	250	397	31.8	173	110	0.3	●	
30 x 47	44	33	50	355	605	40.4	162	110	0.4	●	
32 x 55	51	38	55	490	764	47.8	166	102	0.6	●	
35 x 55	51	38	55	490	836	47.8	151	102	0.6	●	
40 x 62	58	43	65	800	1329	66.5	152	98	0.8	●	
45 x 65	63	48	65	900	1605	71.0	142	98	0.9	●	
48 x 75	73	58	75	1290	2227	92.0	121	77	1.5	●	
50 x 75	73	58	75	1290	2320	92.0	116	77	1.4	●	

● Sizes of clamping elements available from stock.

¹⁾ These are the maximum screw tightening torques. They can be reduced by a maximum of 40 % of the above-mentioned figures with T, F_{ax}, P_W and P_N decreasing proportionately.

CLAMPEX® – KTR 131											
d x D [mm]	Dimensions [mm]			Hexagon nut/ counter hexagon nut		Transmittable torque or axial force		Surface pressure between clamping element		Weight [-kg]	Stock programme
	B	B ₁	B ₂	Width across flats SW	T _A [Nm] ¹⁾	T [Nm]	F _{ax} [kN]	Shaft P _W [N/mm ²]	Hub P _N [N/mm ²]		
5 x 12	19	15	9	14	10	10.1	4.0	264	119	0.02	●
6 x 12	19	15	9	14	10	12.1	4.0	220	119	0.02	●
8 x 14	22	17	11	17	17	23.4	5.8	179	121	0.02	●
10 x 18	24	19	12	22	35	48.6	9.7	221	127	0.04	●
12 x 20	24	19	12	22	44	65.3	10.9	206	128	0.04	●
14 x 24	28	22	15	27	65	93.0	13.3	178	107	0.08	●
15 x 24	28	22	15	27	65	99.0	13.3	166	107	0.07	●
16 x 24	28	22	15	27	65	106	13.3	156	107	0.07	●
18 x 30	36	27	17	36	161	223	24.8	224	145	0.2	●
19 x 30	36	27	17	36	161	235	24.8	212	145	0.2	●
20 x 30	36	27	17	36	161	248	24.8	201	145	0.15	●
22 x 38	41	30	20	46	250	349	31.8	197	122	0.35	●
24 x 38	41	30	20	46	250	381	31.8	180	122	0.3	●
25 x 38	41	30	20	46	250	397	31.8	173	122	0.3	●
30 x 42	44	33	23	50	355	605	40.4	162	123	0.35	●
32 x 50	51	38	28	55	490	764	47.8	166	112	0.55	●
35 x 50	51	38	28	55	490	836	47.8	151	112	0.5	●

● Sizes of clamping elements available from stock.

¹⁾ These are the maximum screw tightening torques. They can be reduced by a maximum of 40 % of the above-mentioned figures with T, F_{ax}, P_W and P_N decreasing proportionately.

CLAMPEX® KTR 150

Clamping elements

Not self-centering clamping element with minimum dimensions



For legend of pictogram refer to flapper on the cover

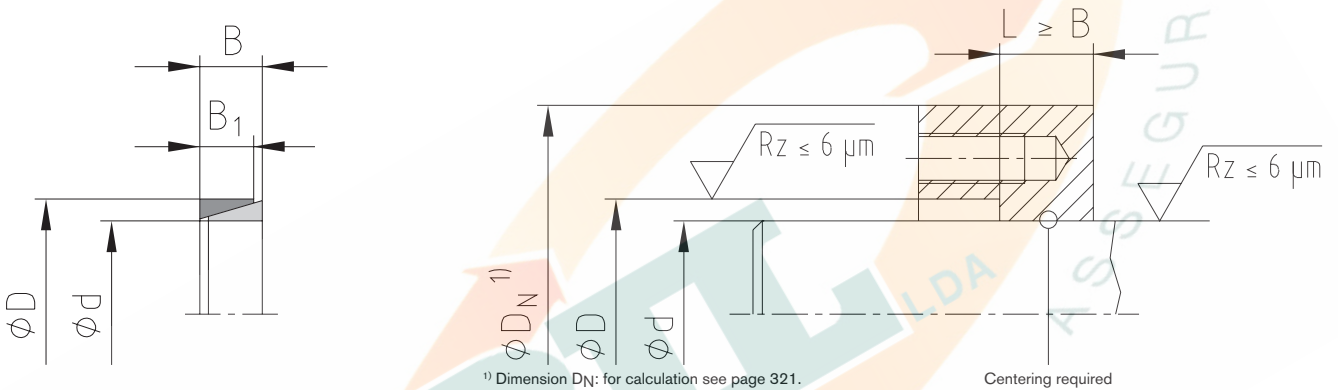
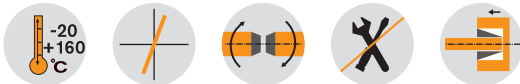

Tolerances for d and D

$d \leq 38 \text{ mm} = d \text{ h6/D H7}$

$d > 38 \text{ mm} = d \text{ h8/D H8}$

Example of application of hub type

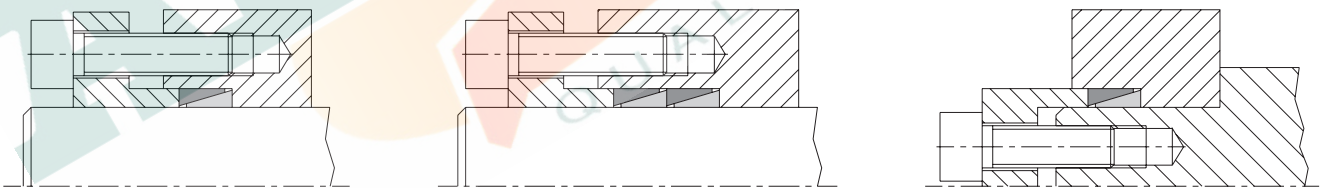

Up to four clamping elements can be installed one after another.

The torques rise as follows:

- 1 clamping element $T = T_{\text{catalogue}} \times 1.00$
- 2 clamping elements $T = T_{\text{catalogue}} \times 1.55$
- 3 clamping elements $T = T_{\text{catalogue}} \times 1.85$
- 4 clamping elements $T = T_{\text{catalogue}} \times 2.02$

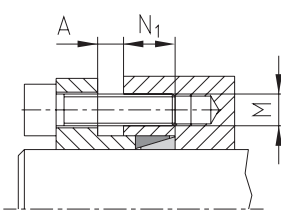

Pressure flanges

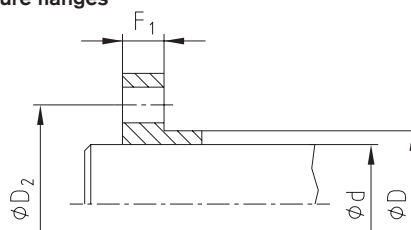

Recommended dimensions of pressure flanges:

- $N_1 \text{ [mm]} \geq 1.5 \cdot B$
- $D_2 \text{ [mm]} = D + 12 + M$
- $F_1 \text{ [mm]} = M \cdot 1.3$ (with screws 8.8)
- $F_1 \text{ [mm]} = M \cdot 1.8$ (with screws 10.9/12.9)

Ordering example:	KTR 150	60	x	68
	Series	Size of internal diameter d		Size of external diameter D

CLAMPEX® – KTR 150

d x D [mm]	Dimensions [mm]		Distance dimension A [mm]				Clamping force required for clamping screws $\mu_{total}=0.14$			Transmittable torque or axial force		Surface pressure between clamping element		Weight [-kg]	Stock programme
	B	B ₁	Clamping elements				P _O [kN]	P _S [kN]	P _A = P _O +P _S [kN]	T [Nm]	F _{ax} [kN]	Shaft P _W [N/mm ²]	Hub P _N [N/mm ²]		
			1	2	3	4									
6 x 9	4.5	3.7	3	3	3	4	0	3	3	2	0.6	80	53	0.0015	●
7 x 10	4.5	3.7	3	3	3	4	0	5	5	4	1	117	82	0.0014	●
8 x 11	4.5	3.7	3	3	3	4	0	6	6	5	1	112	81	0.0015	●
9 x 12	4.5	3.7	3	3	3	4	8	8	16	8	1	142	106	0.0017	●
10 x 13	4.5	3.7	3	3	3	4	7	9	16	10	2	143	110	0.0018	●
12 x 15	4.5	3.7	3	3	3	4	7	8	15	11	1	110	88	0.0022	●
13 x 16	4.5	3.7	3	3	3	4	6	10	16	13	2	110	90	0.0023	●
14 x 18	6.3	5.3	3	4	4	5	11	15	26	22	3	112	87	0.0049	●
15 x 19	6.3	5.3	3	4	4	5	11	15	26	25	3	111	88	0.0053	●
16 x 20	6.3	5.3	3	4	4	5	10	15	25	26	3	102	81	0.0055	●
17 x 21	6.3	5.3	3	4	4	5	10	16	26	30	3	104	84	0.0058	●
18 x 22	6.3	5.3	3	4	4	5	9	17	26	33	3	102	83	0.0061	●
19 x 24	6.3	5.3	3	4	4	5	13	19	32	40	4	111	88	0.0078	●
20 x 25	6.3	5.3	3	4	4	5	12	20	32	44	4	110	88	0.0082	●
22 x 26	6.3	5.3	3	4	4	5	9	21	30	50	4	103	87	0.0072	●
24 x 28	6.3	5.3	3	4	4	5	8	26	34	68	5	118	101	0.0079	●
25 x 30	6.3	5.3	3	4	4	5	10	27	37	75	6	120	100	0.01	●
28 x 32	6.3	5.3	3	4	4	5	7	30	37	90	6	115	101	0.009	●
30 x 35	6.3	5.3	3	4	4	5	8	31	39	100	6	111	95	0.012	●
32 x 36	6.3	5.3	3	4	4	5	8	34	42	120	7	117	104	0.01	●
35 x 40	7	6.0	3	4	4	5	13	42	55	160	9	115	101	0.02	●
36 x 42	7	6.0	4	5	5	6	15	43	58	170	9	116	99	0.02	●
38 x 44	7	6.0	4	5	5	6	14	46	60	190	10	116	100	0.02	●
40 x 45	8	6.6	4	5	5	6	14	53	67	230	11	116	103	0.02	●
42 x 48	8	6.6	4	5	5	6	16	57	73	260	12	118	104	0.03	●
45 x 52	10	8.6	4	5	5	6	26	80	106	390	17	119	103	0.05	●
48 x 55	10	8.6	4	5	5	6	25	82	107	430	17	115	100	0.05	●
50 x 57	10	8.6	4	5	5	6	24	86	110	470	18	116	102	0.05	●
55 x 62	10	8.6	4	5	5	6	22	97	119	580	21	118	105	0.05	●
56 x 64	12	10.4	4	5	5	6	29	122	151	740	26	120	105	0.07	●
60 x 68	12	10.4	4	5	6	7	27	129	156	840	28	119	105	0.07	●
63 x 71	12	10.4	4	5	6	7	26	134	160	920	29	118	105	0.08	●
65 x 73	12	10.4	4	5	6	7	25	142	167	1000	30	121	108	0.08	●
70 x 79	14	12.2	4	5	6	7	31	171	202	1300	37	115	102	0.11	●
71 x 80	14	12.2	4	5	6	7	31	181	212	1400	39	121	107	0.11	●
75 x 84	14	12.2	4	5	6	7	34	184	218	1500	40	116	104	0.12	●
80 x 91	17	15.0	5	6	7	8	48	241	289	2100	52	116	102	0.12	●
85 x 96	17	15.0	5	6	7	8	45	260	305	2400	56	117	104	0.2	●
90 x 101	17	15.0	5	6	7	8	43	276	319	2700	60	118	105	0.2	●
95 x 106	17	15.0	5	6	8	9	41	290	331	3000	63	118	105	0.22	●
100 x 114	21	18.7	5	6	8	9	61	386	447	4200	84	119	105	0.4	●
110 x 124	21	18.7	5	6	8	9	65	393	458	4700	85	110	98	0.4	●
120 x 134	21	18.7	5	6	8	9	60	391	451	5100	85	100	90	0.5	●
130 x 148	28	25.3	6	7	9	11	96	573	669	8100	124	101	88	0.85	●
140 x 158	28	25.3	6	7	9	11	89	618	707	9400	134	101	89	0.91	●
150 x 168	28	25.3	6	7	9	11	84	674	758	11000	146	103	92	0.97	●
160 x 178	28	25.3	6	7	9	11	79	833	912	14500	181	119	107	1.02	●
170 x 191	33	30.0	7	8	10	12	118	1054	1172	19500	229	119	106	1.5	●
180 x 201	33	30.0	7	8	10	12	112	1082	1194	21200	235	116	104	1.6	●
190 x 211	33	30.0	7	9	10	12	106	1166	1272	24100	253	118	106	1.7	●
200 x 224	38	34.5	7	9	11	13	133	1425	1558	31000	310	119	106	2.3	●
210 x 234	38	34.5	7	9	11	13	127	1532	1659	35000	333	122	110	2.5	●
220 x 244	38	34.5	7	9	11	13	122	1587	1709	38000	345	121	109	2.5	●
230 x 257	43	39.5	7	9	12	14	165	1579	1744	39500	343	100	90	3.4	●
240 x 267	43	39.5	7	9	12	14	158	1801	1959	47000	391	110	99	3.5	●
250 x 280	48	44.0	8	10	13	16	188	1912	2100	52000	416	100	90	4.7	●
260 x 290	48	44.0	8	10	13	16	181	1997	2178	56500	434	101	90	4.8	●
270 x 300	48	44.0	8	10	13	16	174	2077	2251	61000	451	101	91	4.9	●
280 x 313	53	49.0	9	11	14	17	205	2381	2586	72500	517	100	90	6.3	●
290 x 323	53	49.0	9	11	14	17	221	2457	2678	77500	534	100	90	6.5	●
300 x 333	53	49.0	9	11	14	17	214	2544	2758	83000	553	100	90	6.7	●
320 x 360	65	59.0	10	15	20	25	291	3275	3566	114000	712	100	89	10.9	●
340 x 380	65	59.0	10	15	20	25	275	3474	3749	128500	755	100	89	11.5	●
360 x 400	65	59.0	10	15	20	25	261	3677	3938	144000	800	100	90	12.2	●
380 x 420	65	59.0	10	15	20	25	269	3870	4139	160000	842	100	90	12.8	●
400 x 440	65	59.0	10	15	20	25	256	4091	4347	178000	890	100	91	13.5	●
420 x 460	65	59.0	10	15	20	25	244	4290	4534	196000	933	100	91	14.1	●
440 x 480	65	59.0	10	15	20	25	234	4492	4726	215000	977	100	92	14.7	●

● Sizes of clamping elements available from stock.
Other sizes on request.

P_A = Total force
P_O = Setting force
P_S = Clamping force

CLAMPEX® KTR 200 and KTR 201

Clamping elements

Self-centering clamping elements with a wide range of applications

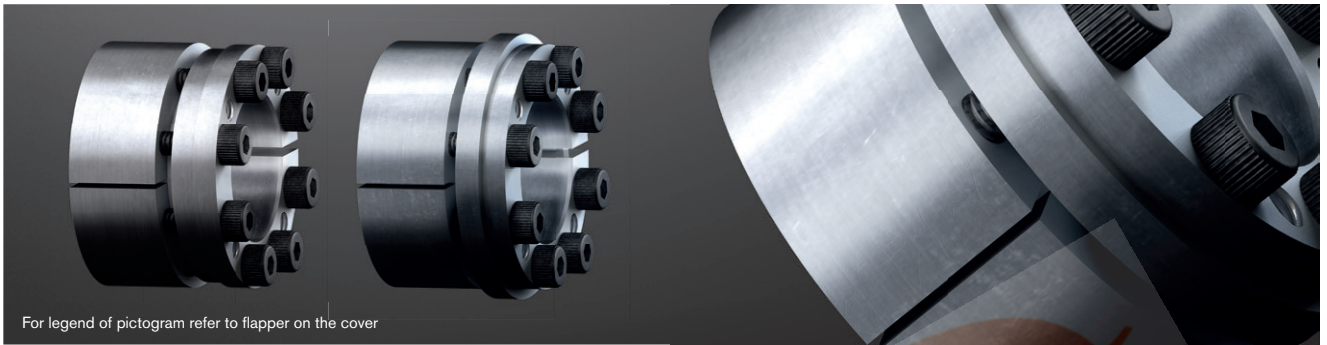

For legend of pictogram refer to flapper on the cover

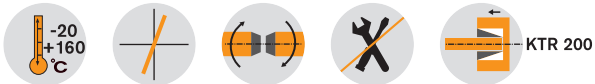

KTR 200

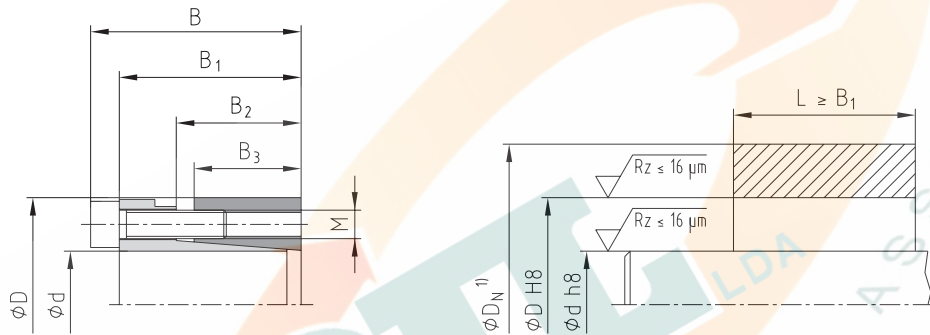

¹⁾ Dimension D_N : for calculation see page 321.

Example of application of hub type

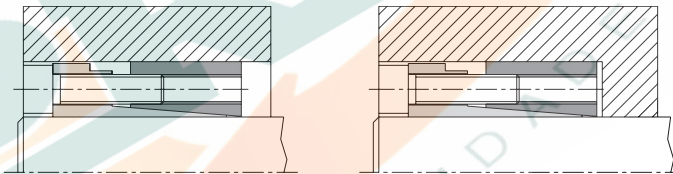

KTR 201

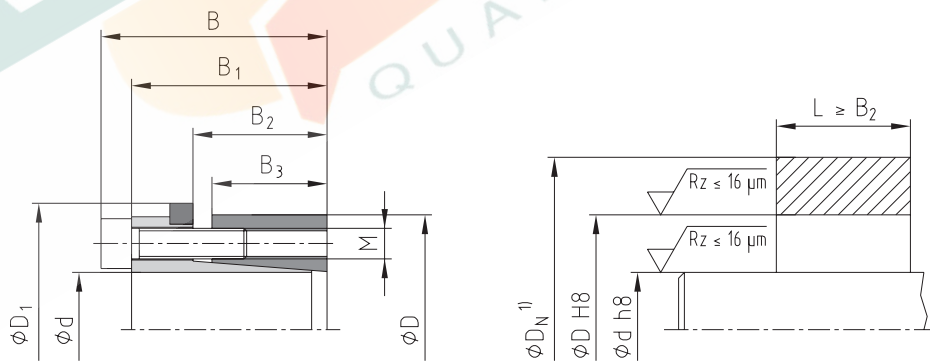

¹⁾ Dimension D_N : for calculation see page 321.

Example of application of hub type

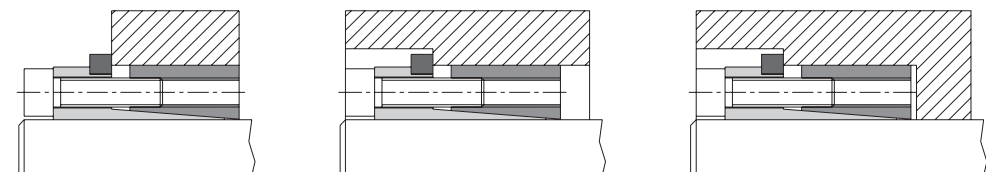

Ordering example:

KTR 200	40	x	65
Series	Size of internal diameter d		Size of external diameter D

CLAMPEX® – KTR 200 and KTR 201

d x D [mm]	Dimensions [mm]					Clamping screws DIN EN ISO 4762 - 12.9 $\mu_{total}=0.14$					KTR 200				KTR 201							
						M	Length	z = number	T _A [Nm] ¹⁾		T [Nm]	F _{ax} [kN]	Surface pressure between clamping element		Weight [-kg]	Stock programme	T [Nm]	F _{ax} [kN]	Surface pressure between clamping element		Weight [-kg]	Stock programme
	KTR 200	KTR 201	Shaft P _W [N/mm ²]	Hub P _N [N/mm ²]	Shaft P _W [N/mm ²]				Hub P _N [N/mm ²]													
20 x 47	48	42	31	26	53	M6	25	6	17	17	530	53	270	115	0.4	●	320	32	163	69	0.4	●
22 x 47	48	42	31	26	53	M6	25	6	17	17	580	53	245	114	0.4	●	360	33	152	71	0.4	●
24 x 50	48	42	31	26	56	M6	25	6	17	17	630	53	223	107	0.4	●	390	33	138	66	0.4	●
25 x 50	48	42	31	26	56	M6	25	6	17	17	660	53	215	108	0.4	●	400	32	131	65	0.4	●
28 x 55	48	42	31	26	61	M6	25	6	17	17	740	53	193	98	0.5	●	450	32	117	60	0.5	●
30 x 55	48	42	31	26	61	M6	25	6	17	17	790	53	179	98	0.5	●	490	33	111	61	0.5	●
32 x 60	48	42	31	26	66	M6	25	8	17	17	1150	72	229	122	0.6	●	690	43	137	73	0.6	●
35 x 60	48	42	31	26	66	M6	25	8	17	17	1300	74	217	126	0.5	●	750	43	125	73	0.5	●
38 x 65	48	42	31	26	71	M6	25	8	17	17	1300	68	184	107	0.6	●	820	43	116	68	0.6	●
40 x 65	48	42	31	26	71	M6	25	8	17	17	1400	70	179	110	0.6	●	860	43	110	67	0.6	●
42 x 75	59	51	35	30	81	M8	30	6	41	41	2000	95	200	112	1.0	●	1300	62	130	73	1.0	●
45 x 75	59	51	35	30	81	M8	30	6	41	41	2200	98	192	115	1.0	●	1400	62	122	73	1.0	●
48 x 80	59	51	35	30	86	M8	30	8	41	41	3200	133	246	147	1.1	●	1900	79	146	87	1.1	●
50 x 80	59	51	35	30	86	M8	30	8	41	41	3300	132	233	146	1.1	●	2000	80	141	88	1.1	●
55 x 85	59	51	35	30	91	M8	30	8	41	41	3600	131	210	136	1.2	●	2200	80	129	83	1.2	●
60 x 90	59	51	35	30	96	M8	30	8	41	41	3900	130	192	128	1.2	●	2400	80	118	79	1.2	●
65 x 95	59	51	35	30	101	M8	30	8	41	41	4300	132	180	123	1.3	●	2600	80	109	74	1.3	●
70 x 110	71	61	46	40	119	M10	30	8	83	83	7500	214	203	129	2.2	●	4600	131	125	79	2.3	●
75 x 115	71	61	46	40	124	M10	30	8	83	83	8000	213	189	123	2.3	●	5000	133	118	77	2.4	●
80 x 120	71	61	46	40	129	M10	30	8	83	83	8500	213	176	117	2.4	●	5200	130	108	72	2.6	●
85 x 125	71	61	46	40	134	M10	30	10	83	83	11400	268	209	142	2.6	●	7000	165	128	87	2.7	●
90 x 130	71	61	46	40	139	M10	30	10	83	83	12000	267	196	136	2.7	●	7400	164	121	84	2.8	●
95 x 135	71	61	46	40	144	M10	30	10	83	83	12600	265	185	130	2.8	●	7800	164	115	81	2.9	●
100 x 145	80	68	52	45	155	M12	35	8	145	145	15000	300	177	122	3.9	●	9800	196	116	80	4.1	●
110 x 155	80	68	52	45	165	M12	35	8	145	145	16500	300	161	114	4.2	●	10700	195	104	74	4.4	●
120 x 165	80	68	52	45	175	M12	35	10	145	145	22500	375	184	134	4.5	●	14600	243	120	87	4.7	●
130 x 180	80	68	52	45	188	M12	35	12	145	145	29000	446	202	146	5.5	●	19000	292	133	96	5.7	●
140 x 190	90	76	58	50	199	M14	40	10	210	230	32000	457	173	128	6.6	●	23000	329	125	92	6.9	●
150 x 200	90	76	58	50	209	M14	40	12	210	230	41000	547	193	145	6.9	●	30000	400	141	106	7.2	●
160 x 210	90	76	58	50	219	M14	40	12	210	230	44000	550	182	139	7.4	●	32000	400	133	101	7.8	●
170 x 225	90	76	58	50	234	M14	40	14	210	230	54500	641	200	151	8.6	●	39000	459	143	108	9.0	●
180 x 235	90	76	58	50	244	M14	40	14	210	230	57500	639	188	144	9.1	●	41000	456	134	103	9.5	●
190 x 250	90	76	58	50	259	M14	40	15	210	230	65000	684	191	145	10.6	●	46400	488	136	104	11.1	●
200 x 260	90	76	58	50	269	M14	40	15	210	230	68000	680	180	139	11.2	●	48800	488	129	100	11.7	●

● Sizes of clamping elements available from stock.

¹⁾ These are the maximum screw tightening torques. They can be reduced by a maximum of 40 % of the above-mentioned figures with T, F_{ax}, P_W and P_N decreasing proportionately.

CLAMPEX® KTR 203 and KTR 206

Clamping elements

Self-centering clamping elements as a compact alternative to KTR 200/201

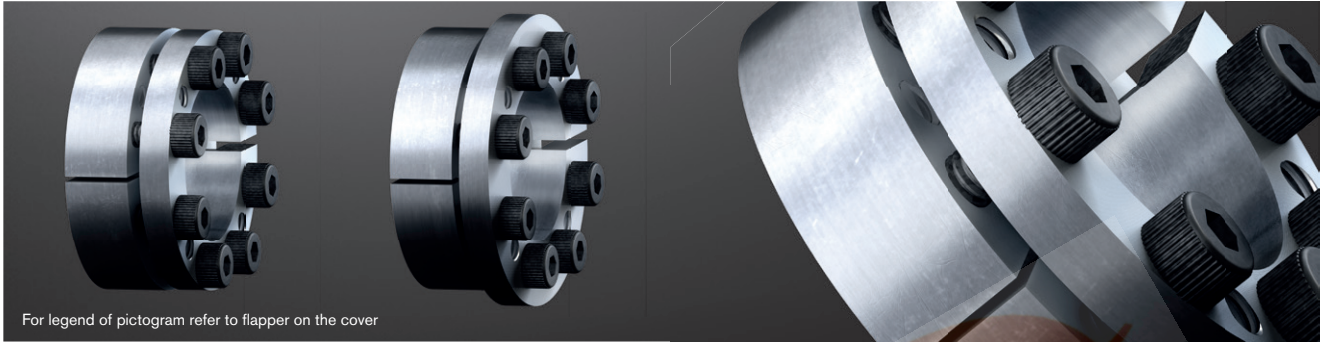

For legend of pictogram refer to flapper on the cover

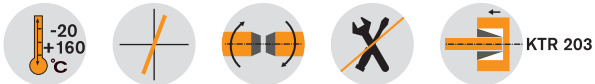

KTR 203

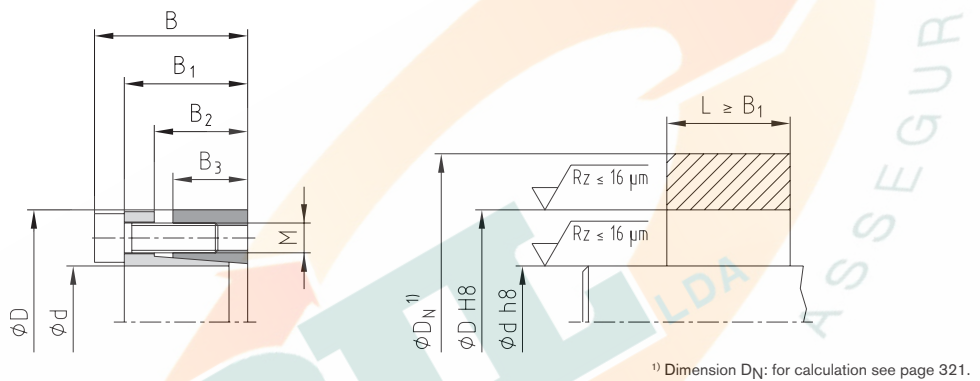

Example of application of hub type

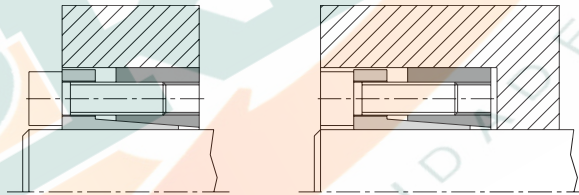

KTR 206

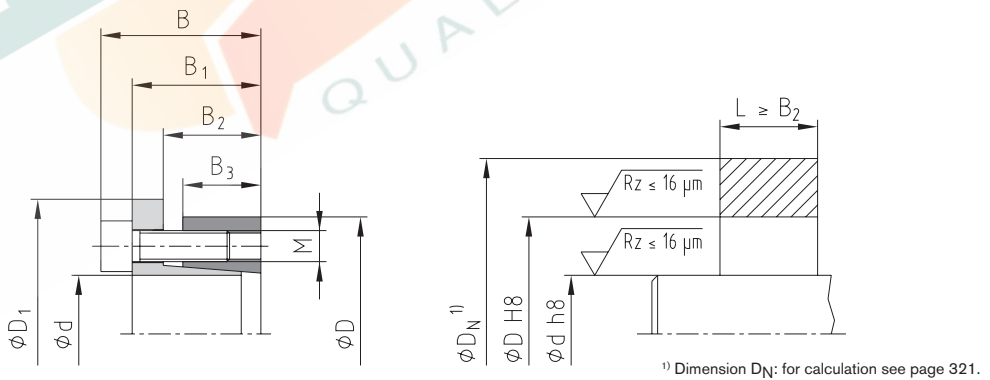

Example of application of hub type

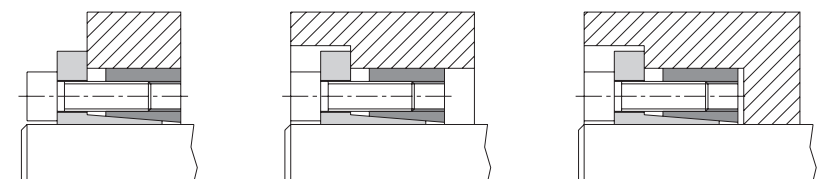

Ordering example:	KTR 203	40	x	65
	Series	Size of internal diameter d		Size of external diameter D

CLAMPEX® – KTR 203 and KTR 206

d x D [mm]	Dimensions [mm]					Clamping screws DIN EN ISO 4762 - 12.9 $\mu_{total}=0.14$					KTR 203						KTR 206					
											Transmittable torque or axial force		Surface pressure between clamping element		Weight [-kg]	Stock programme	Transmittable torque or axial force		Surface pressure between clamping element		Weight [-kg]	Stock programme
	T [Nm]	F _{ax} [kN]	Shaft P _W [N/mm ²]	Hub P _N [N/mm ²]	T [Nm]	F _{ax} [kN]	Shaft P _W [N/mm ²]	Hub P _N [N/mm ²]														
18 x 47	34	28	22	17	53	M6	20	6	14	17	370	41	356	136	0.3	●	290	32	279	107	0.3	●
19 x 47	34	28	22	17	53	M6	20	6	14	17	390	41	337	136	0.3	●	300	32	259	105	0.3	●
20 x 47	34	28	22	17	53	M6	20	6	14	17	410	41	320	136	0.3	●	320	32	250	106	0.3	●
22 x 47	34	28	22	17	53	M6	20	6	14	17	450	41	290	136	0.3	●	350	32	226	106	0.3	●
24 x 50	34	28	22	17	56	M6	20	6	14	17	490	41	265	127	0.3	●	390	33	211	101	0.3	●
25 x 50	34	28	22	17	56	M6	20	6	14	17	510	41	255	127	0.3	●	400	32	200	100	0.3	●
28 x 55	34	28	22	17	61.4	M6	20	6	14	17	570	41	227	116	0.3	●	450	32	179	91	0.4	●
30 x 55	34	28	22	17	61.4	M6	20	6	14	17	610	41	212	115	0.3	●	490	33	170	93	0.3	●
32 x 60	34	28	22	17.5	67	M6	20	8	14	17	880	55	261	139	0.4	●	700	44	207	111	0.3	●
35 x 60	34	28	22	17.5	67	M6	20	8	14	17	960	55	238	139	0.3	●	760	43	188	110	0.4	●
38 x 65	34	28	22	17.5	72	M6	20	8	14	17	1000	53	210	123	0.4	●	820	43	172	101	0.5	●
40 x 65	34	28	22	17.5	72	M6	20	8	14	17	1100	55	208	128	0.4	●	870	44	165	101	0.4	●
42 x 75	41	33	25	20	84	M8	25	8	35	41	2200	105	331	185	0.6	●	1700	81	256	143	0.7	●
45 x 75	41	33	25	20	84	M8	25	8	35	41	2400	107	314	189	0.6	●	1800	80	236	141	0.7	●
48 x 80	41	33.5	24	20	89	M8	25	8	35	41	2500	104	288	173	0.7	●	1900	79	219	131	0.8	●
50 x 80	41	33.5	24	20	89	M8	25	8	35	41	2600	104	276	172	0.7	●	2000	80	212	133	0.8	●
55 x 85	41	33.5	24	20	94	M8	25	8	35	41	2900	105	254	165	0.7	●	2200	80	193	125	0.9	●
60 x 90	41	33.5	24	20	99	M8	25	8	35	41	3100	103	228	152	0.8	●	2400	80	177	118	0.9	●
65 x 95	41	33.5	24	20	104	M8	25	8	35	41	3400	105	213	146	0.8	●	2600	80	163	112	0.9	●
70 x 110	50	40	29	24	119	M10	30	8	70	83	6000	171	271	172	1.5	●	4600	131	208	132	1.6	●
75 x 115	50	40	29	24	124	M10	30	8	70	83	6400	171	252	164	1.6	●	5000	133	196	128	1.7	●
80 x 120	50	40	29	24	129	M10	30	8	70	83	6800	170	235	157	1.7	●	5300	133	183	122	1.9	●
85 x 125	50	40	29	24	134	M10	30	10	70	83	9000	212	275	187	1.8	●	7000	165	214	146	2.0	●
90 x 130	50	40	29	24	139	M10	30	10	70	83	9600	213	262	181	1.9	●	7400	164	202	140	2.0	●
95 x 135	50	40	29	24	144	M10	30	10	70	83	10200	215	250	176	2.0	●	7800	164	191	134	2.3	●
100 x 145	56	44	31	25.5	154	M12	30	8	115	145	12000	240	250	172	2.6	●	9700	194	202	139	2.8	●
110 x 155	56	44	31	25.5	164	M12	30	8	115	145	13000	236	224	159	2.8	●	10700	195	184	131	3.1	●
120 x 165	56	44	31	26	174	M12	30	9	115	145	16000	267	227	165	3.6	●	13100	218	186	135	3.2	●
130 x 180	64	52	39	34	189	M12	30	12	115	145	23000	354	212	153	4.4	●	19000	292	175	127	4.6	●
140 x 190	68	54	39	34	199	M14	40	9	185	230	25000	357	199	147	4.9	●	20500	293	163	120	5.0	●
150 x 200	68	54	39	34	209	M14	40	10	185	230	30000	400	208	156	5.2	●	24500	327	170	127	5.2	●
160 x 210	68	54	39	34	219	M14	40	12	185	230	38800	485	236	180	5.6	●	31300	391	191	145	5.6	●
170 x 225	78	64	49	44	234	M14	40	12	185	230	41300	486	172	130	6.9	●	33200	391	139	105	6.5	●
180 x 235	78	64	49	44	244	M14	40	12	185	230	43700	486	163	125	8.5	●	35000	389	130	100	8.5	●
190 x 250	78	64	49	43.5	259	M14	40	15	185	230	57700	607	195	148	9.0	●	46500	489	157	119	9.0	●
200 x 260	78	64	49	43.5	269	M14	40	15	185	230	60700	607	185	142	9.6	●	49000	490	149	115	9.6	●
220 x 285	88	72	57	50	294	M16	40	12	290	360	77300	703	169	131	13.4	●	57100	519	125	97	14.0	●
240 x 305	88	72	57	50	314	M16	40	15	290	360	105400	878	194	153	14.5	●	77800	648	143	113	15.1	●
260 x 325	88	72	57	50	334	M16	40	18	290	360	137000	1054	215	172	16.1	●	101200	778	159	127	16.2	●
280 x 355	102	84	66	60	364	M18	50	16	400	480	160300	1145	181	143	23.4	●	113300	809	128	101	25.6	●
300 x 375	102	84	66	60	384	M18	50	18	400	480	193200	1288	190	152	25.3	●	136500	910	134	107	25.5	●
320 x 405	121	101	81	74	414	M20	50	18	580	690	269300	1683	189	149	36.9	●	191000	1194	134	106	37.9	●
340 x 425	121	101	81	74	434	M20	50	21	580	690	333800	1964	207	166	39.0	●	237000	1394	147	118	38.3	●
360 x 455	138	116	93	86	464	M22	60	18	780	930	375700	2087	179	141	54.0	●	264000	1467	126	99	53.3	●
380 x 475	138	116	93	86	484	M22	60	21	780	930	462700	2435	198	158	56.2	●	325000	1711	139	111	57.6	●
400 x 495	138	116	93	86	504	M22	60	21	780	930	487000	2435	188	152	58.9	●	342000	1710	132	107	60.3	●

● Sizes of clamping elements available from stock.

¹⁾ These are the maximum screw tightening torques. They can be reduced by a maximum of 40 % of the above-mentioned figures with T, F_{ax}, P_W and P_N decreasing proportionately.

CLAMPEX® KTR 225

Clamping elements

Self-centering, combination of a hub \emptyset with various shaft \emptyset



For legend of pictogram refer to flapper on the cover

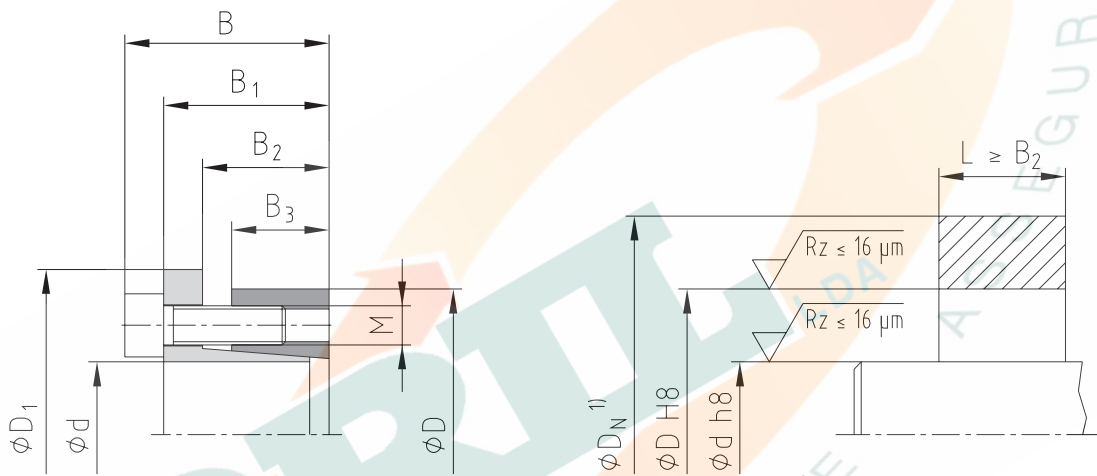

¹⁾ Dimension D_N : for calculation see page 321.

Example of application of hub type

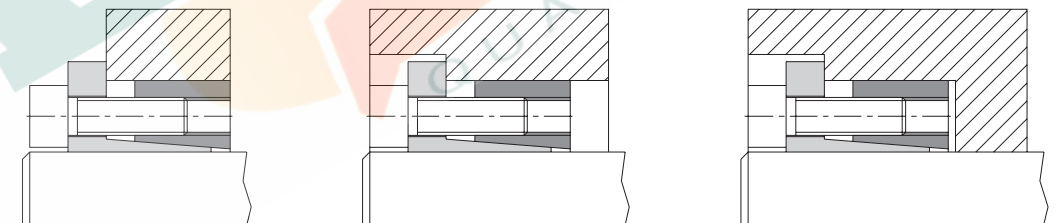

To fasten one size of hubs on different shaft diameters

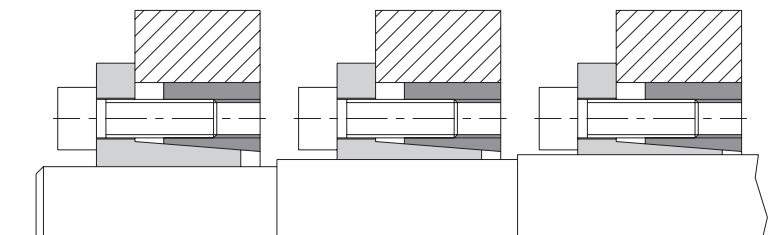

Ordering example:	KTR 225	28	x	65
	Series	Size of internal diameter d		Size of external diameter D

CLAMPEX® – KTR 225															
d x D [mm]	Dimensions [mm]					Clamping screws DIN EN ISO 4762 - 12.9 $\mu_{total}=0.14$				Transmittable torque or axial force		Surface pressure between clamping element		Weight [-kg]	Stock programme
	B	B ₁	B ₂	B ₃	D ₁	M	Length	z = number	T _A ¹⁾ [Nm]	T [Nm]	F _{ax} [kN]	Shaft P _W [N/mm ²]	Hub P _N [N/mm ²]		
14 x 55	38	30	22	17	62	M8	25	4	41	287	41	457	116	0.5	●
16 x 55	38	30	22	17	62	M8	25	4	41	329	41	401	117	0.5	●
18 x 55	38	30	22	17	62	M8	25	4	41	370	41	356	117	0.5	●
19 x 55	38	30	22	17	62	M8	25	4	41	390	41	337	116	0.5	●
20 x 55	38	30	22	17	62	M8	25	4	41	410	41	320	116	0.5	●
22 x 55	38	30	22	17	62	M8	25	4	41	451	41	291	116	0.5	●
24 x 55	38	30	22	17	62	M8	25	4	41	492	41	267	116	0.4	●
25 x 55	38	30	22	17	62	M8	25	4	41	513	41	256	116	0.4	●
28 x 55	38	30	22	17	62	M8	25	4	41	575	41	229	117	0.4	●
30 x 55	38	30	22	17	62	M8	25	4	41	616	41	214	117	0.4	●
24 x 65	38	30	22	17	72	M8	25	5	41	616	51	334	123	0.7	●
25 x 65	38	30	22	17	72	M8	25	5	41	641	51	320	123	0.7	●
28 x 65	38	30	22	17	72	M8	25	5	41	718	51	286	123	0.6	●
30 x 65	38	30	22	17	72	M8	25	5	41	770	51	267	123	0.6	●
32 x 65	38	30	22	17	72	M8	25	5	41	821	51	250	123	0.6	●
35 x 65	38	30	22	17	72	M8	25	5	41	898	51	229	123	0.5	●
38 x 65	38	30	22	17	72	M8	25	5	41	975	51	211	123	0.5	●
40 x 65	38	30	22	17	72	M8	25	5	41	1026	51	200	123	0.5	●
30 x 80	41	33	25	20	88	M8	25	7	41	1077	72	317	119	1.1	
32 x 80	41	33	25	20	88	M8	25	7	41	1150	72	298	119	1.1	
35 x 80	41	33	25	20	88	M8	25	7	41	1257	72	272	119	1.0	
38 x 80	41	33	25	20	88	M8	25	7	41	1364	72	251	119	1.0	
40 x 80	41	33	25	20	88	M8	25	7	41	1436	72	238	119	0.9	●
42 x 80	41	33	25	20	88	M8	25	7	41	1509	72	227	119	0.9	
45 x 80	41	33	25	20	88	M8	25	7	41	1616	72	212	119	0.9	
48 x 80	41	33	25	20	88	M8	25	7	41	1723	72	198	119	0.8	
50 x 80	41	33	25	20	88	M8	25	7	41	1796	72	191	119	0.8	●

● Sizes of clamping elements available from stock.

¹⁾ These are the maximum screw tightening torques. They can be reduced by a maximum of 40 % of the above-mentioned figures with T, F_{ax}, P_W and P_N decreasing proportionately.

CLAMPEX® KTR 250

Clamping elements

Self-centering clamping element, particularly suitable for thin-walled hubs

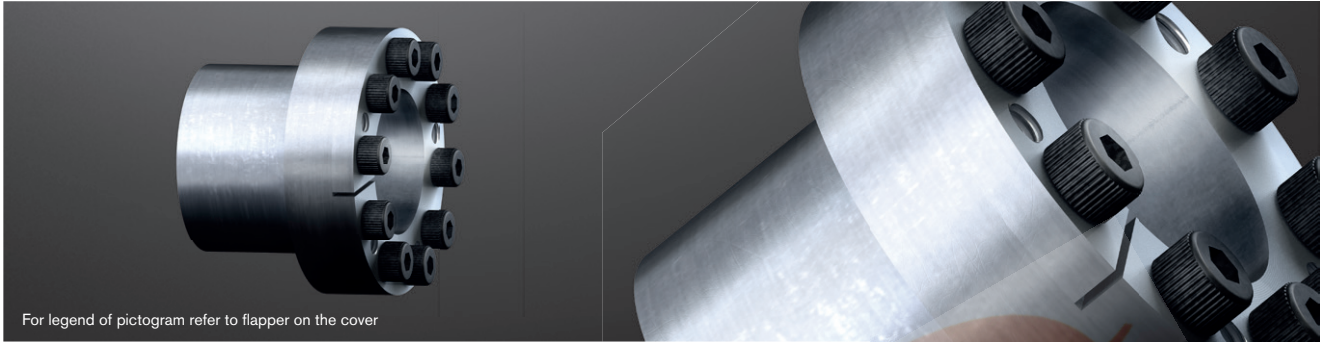

For legend of pictogram refer to flapper on the cover

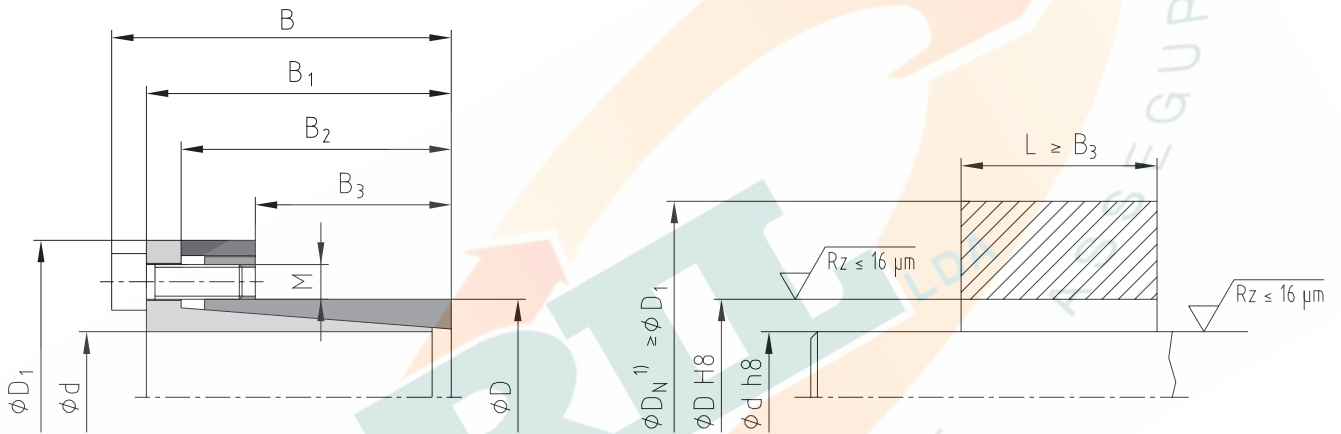

¹⁾ Dimension D_N : for calculation see page 321.

Example of application of hub type

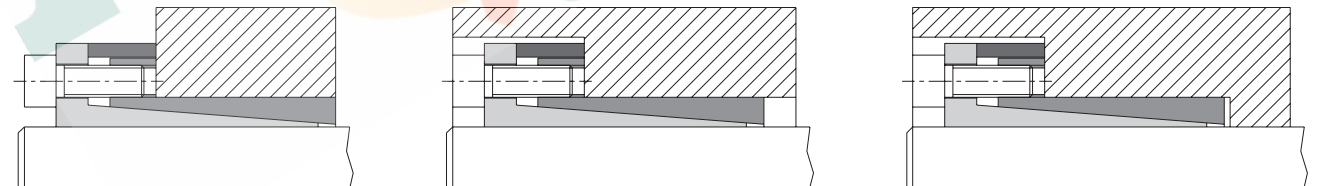

Ordering example:	KTR 250	28	x	39
	Series	Size of internal diameter d		Size of external diameter D

CLAMPEX® – KTR 250

d x D [mm]	Dimensions [mm]					Clamping screws DIN EN ISO 4762 - 12.9 $\mu_{total}=0.14$				Transmittable torque or axial force		Surface pressure be- tween clamping element		Weight [~kg]	Stock pro- gramme
	B	B ₁	B ₂	B ₃	D ₁	M	Length	z = number	T _A [Nm] ¹⁾	T [Nm]	F _{ax} [kN]	Shaft P _W [N/mm ²]	Hub P _N [N/ mm ²]		
6 x 14	24.5	21.5	18.5	10	25	M3	10	4	2.6	11	4	162	69	0.05	●
8 x 15	29	25	21.5	11.5	27	M4	10	3	5.6	26	7	187	100	0.05	●
9 x 16	30	26	22.5	14	28	M4	10	4	5.6	37	8	173	97	0.06	●
10 x 16	30	26	22.5	14	29	M4	10	4	5.6	42	8	159	99	0.16	●
11 x 18	30	26	22.5	13.5	32	M4	10	4	5.6	50	9	162	99	0.18	●
12 x 18	30	26	22.5	13.5	32	M4	10	4	5.6	55	9	150	100	0.18	●
14 x 23	30	26	22.5	14	38	M4	10	6	5.6	100	14	193	118	0.20	●
15 x 24	42	36	28.5	16	44	M6	18	4	15	145	19	214	134	0.2	●
16 x 24	42	36	28.5	16	44	M6	18	4	15	155	19	201	134	0.3	●
17 x 25	42	36	28.5	16	45	M6	18	4	15	162	19	186	126	0.2	●
17 x 26	44	38	31	18	47	M6	18	4	17	180	21	184	120	0.2	●
18 x 26	44	38	31	18	47	M6	18	4	17	200	22	182	126	0.2	●
19 x 27	44	38	31	18	48	M6	18	4	17	210	22	171	121	0.3	●
20 x 28	44	38	31	18	49	M6	18	4	17	220	22	162	116	0.2	●
22 x 32	51	45	38	25	54	M6	18	4	17	250	23	110	75	0.3	●
24 x 34	51	45	38	25	56	M6	18	4	17	270	23	99	70	0.3	●
25 x 34	51	45	38	25	56	M6	18	4	17	280	22	95	70	0.3	●
28 x 39	51	45	38	25	61	M6	18	6	17	480	34	130	93	0.4	●
30 x 41	51	45	38	25	62	M6	18	6	17	510	34	120	88	0.4	●
32 x 43	51	45	38	25	65	M6	18	8	17	730	46	151	113	0.5	●
35 x 47	56	50	43	30	69	M6	18	8	17	800	46	115	86	0.5	●
38 x 50	56	50	43	30	72	M6	18	8	17	860	45	105	80	0.6	●
40 x 53	56	50	43	30	75	M6	18	8	17	900	45	99	75	0.6	●
42 x 55	65	57	49	32	78	M8	22	8	41	1800	86	169	129	0.9	●
45 x 59	73	65	57	40	85	M8	22	8	41	1900	84	124	95	1.0	●
48 x 62	78	70	62	45	87	M8	22	8	41	2000	83	102	79	1.0	●
50 x 65	78	70	62	45	92	M8	22	10	41	2600	104	123	94	1.3	●
55 x 71	83	75	67	50	98	M8	22	10	41	2900	105	102	79	1.5	●
60 x 77	83	75	67	50	104	M8	22	10	41	3100	103	91	71	1.7	●
65 x 84	83	75	67	50	111	M8	22	10	41	3400	105	85	66	1.9	●
70 x 90	101	91	80	60	119	M10	25	10	83	5800	166	105	81	2.9	●
75 x 95	101	91	80	60	126	M10	25	10	83	6200	165	97	77	2.3	●
80 x 100	106	96	85	65	131	M10	25	12	83	8000	200	102	82	3.3	●
85 x 106	106	96	85	65	137	M10	25	12	83	8500	200	96	77	3.6	●
90 x 112	106	96	85	65	143	M10	25	15	83	11200	249	113	91	3.9	●
95 x 120	106	96	85	65	153	M10	25	15	83	11800	248	107	84	4.5	●
100 x 125	114	102	89	65	162	M12	30	12	145	14600	292	119	95	5.5	●
110 x 140	140	128	114	90	180	M12	30	12	145	16000	291	78	61	8.0	●
120 x 155	140	128	114	90	198	M12	30	12	145	17400	290	71	55	10.5	●
130 x 165	140	128	114	90	208	M12	30	16	145	25000	385	87	69	11.9	●

● Sizes of clamping elements available from stock.

¹⁾ These are the maximum screw tightening torques. They can be reduced by a maximum of 40 % of the above-mentioned figures with T, F_{ax}, P_W and P_N decreasing proportionately.

CLAMPEX® KTR 400

Clamping elements

Self-centering clamping element with highest transmission performance

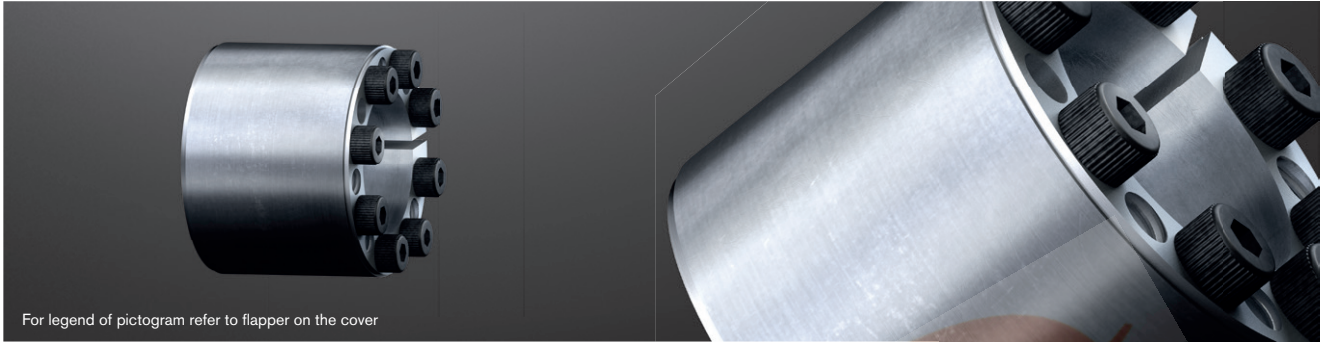

For legend of pictogram refer to flapper on the cover

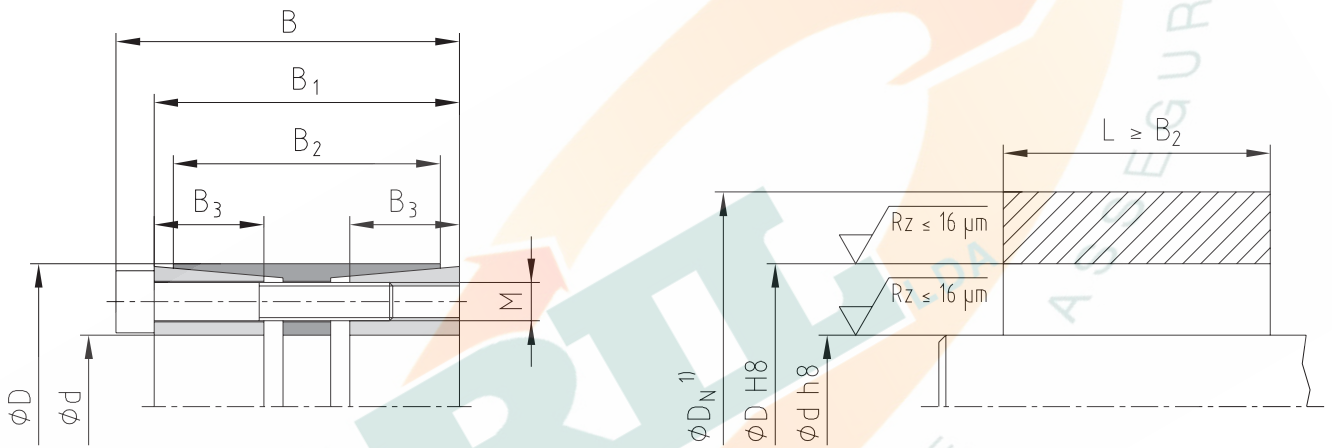
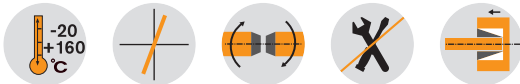

¹⁾ Dimension D_N : for calculation see page 321.

Example of application of hub type

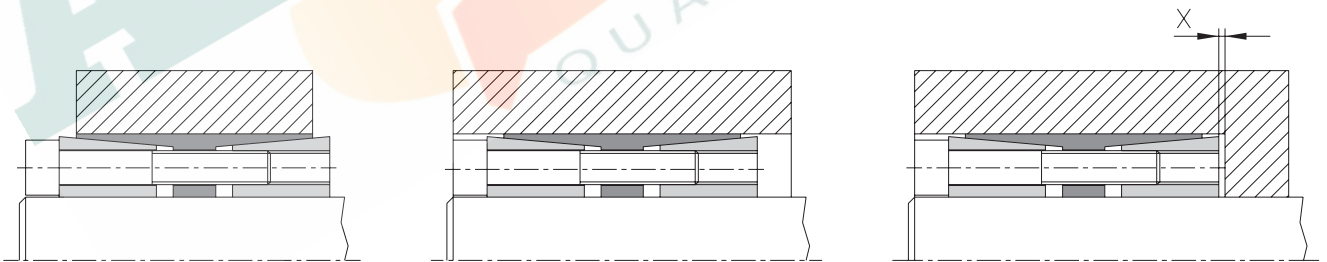

Formula to calculate space x for disassembly:

$$x = \frac{B_1 - B_2}{2}$$

Ordering example:	KTR 400	100	x	145
	Series	Size of internal diameter d		Size of external diameter D

CLAMPEX® – KTR 400

d x D ¹⁾ [mm]	Dimensions [mm]				Standard applications in industry								Applications with components subjected to bending and torsion stress								Weight [-kg]	Stock programme	
					Clamping screws DIN EN ISO 4762 - 12.9 μ _{total} =0.14				Transmittable torque or axial force		Surface pressure between clamp- ing element		Clamping screws DIN EN ISO 4762 - 12.9 μ _{total} =0.14				Transmittable torque or axial force		Transmit- table bending moment				Surface pressure between clamp- ing element
	B	B ₁	B ₂	B ₃	M	z = num- ber	Length	T _A ²⁾ [Nm]	T [Nm]	F _{ax} [kN]	Shaft P _W [N/mm ²]	Hub P _N [N/mm ²]	M	z = num- ber	Length	T _A [Nm]	T [Nm]	F _{ax} [kN]	M _b perm. [Nm]	Shaft P _W [N/mm ²]			Hub P _N [N/mm ²]
24 x 50	51	45	41	16	M6	6	35	17	700	58	202	92	M6	6	35	14	460	38	420	230	93	0.5	●
25 x 50	51	45	41	16	M6	6	35	17	730	58	194	92	M6	6	35	14	470	38	430	227	94	0.5	●
28 x 55	51	45	41	16	M6	8	35	17	1100	79	233	112	M6	8	35	14	740	53	490	252	110	0.5	●
30 x 55	51	45	41	16	M6	8	35	17	1180	79	217	112	M6	8	35	14	790	53	520	243	112	0.5	●
32 x 60	51	45	41	16	M6	8	35	17	1270	79	206	103	M6	8	35	14	830	52	560	230	104	0.8	●
35 x 60	51	45	41	16	M6	8	35	17	1390	79	188	104	M6	8	35	14	890	51	610	214	106	0.7	●
38 x 65	51	45	41	16	M6	10	35	17	1880	99	216	119	M6	10	35	14	1250	66	660	240	119	1.1	●
40 x 65	51	45	41	16	M6	10	35	17	1980	99	205	119	M6	10	35	14	1300	65	700	230	120	1.1	●
40 x 75	51	45	41	16	M8	8	35	41	2850	143	296	149	M8	8	35	35	2030	102	700	320	142	1.1	●
42 x 75	51	45	41	16	M8	8	35	41	3000	143	282	149	M8	8	35	35	2120	101	730	307	142	1.2	●
45 x 75	51	45	41	16	M8	8	35	41	3250	144	266	151	M8	8	35	35	2260	100	780	289	145	1.1	●
48 x 80	70	62	58	23	M8	8	55	41	3450	144	173	98	M8	8	55	35	2160	90	1700	202	101	1.5	●
50 x 80	70	62	58	23	M8	8	55	41	3600	144	166	98	M8	8	55	35	2220	89	1770	196	102	1.4	●
55 x 85	70	62	58	23	M8	8	55	41	3950	144	151	92	M8	8	55	35	2350	85	1950	182	98	1.5	●
60 x 90	70	62	58	23	M8	10	55	41	5400	180	173	109	M8	10	55	35	3380	113	2130	202	113	1.6	●
65 x 95	70	62	58	23	M8	10	55	41	5850	180	160	103	M8	10	55	35	3560	110	2310	190	109	1.7	●
70 x 110	86	76	70	28	M10	10	60	83	10200	291	197	118	M10	10	60	69	6620	189	3650	222	120	3.1	●
75 x 115	86	76	70	28	M10	10	60	83	10950	292	184	113	M10	10	60	69	6970	186	3920	210	117	3.3	●
80 x 120	86	76	70	28	M10	12	60	83	14000	350	207	130	M10	12	60	69	9210	230	4180	231	131	3.5	●
85 x 125	86	76	70	28	M10	12	60	83	15000	353	197	126	M10	12	60	69	9710	228	4440	220	129	3.6	●
90 x 130	86	76	70	28	M10	12	60	83	15800	351	185	121	M10	12	60	69	10000	222	4700	210	124	3.8	●
95 x 135	86	76	70	28	M10	12	60	83	16800	354	176	117	M10	12	60	69	10500	221	4960	201	122	4.0	●
100 x 145	110	98	92	35	M12	12	80	145	26000	520	197	121	M12	12	80	120	16850	337	8580	219	124	6.1	●
110 x 155	110	98	92	35	M12	12	80	145	28600	520	179	114	M12	12	80	120	18000	327	9440	203	118	6.6	●
120 x 165	110	98	92	35	M12	14	80	145	36300	605	191	124	M12	14	80	120	23350	389	10300	214	128	7.1	●
130 x 180	128	114	108	41	M14	12	90	230	46000	708	176	114	M14	12	90	190	29950	461	15300	201	119	10.0	●
140 x 190	128	114	108	41	M14	14	90	230	57800	826	191	126	M14	14	90	190	37200	531	16500	214	129	10.6	●
150 x 200	128	114	108	41	M14	16	90	230	70800	944	204	136	M14	16	90	190	46400	619	17700	226	139	11.2	●
160 x 210	128	114	108	41	M14	16	90	230	75500	944	191	130	M14	16	90	190	48600	608	18800	214	133	11.9	●
170 x 225	162	146	136	52	M16	14	110	355	95900	1128	169	114	M16	14	110	295	59100	695	32000	196	119	17.6	●
180 x 235	162	146	136	52	M16	15	110	355	108800	1209	171	117	M16	15	110	295	67500	750	33900	198	122	18.5	●
190 x 250	162	146	136	52	M16	16	110	355	122500	1289	173	117	M16	16	110	295	76100	801	35800	199	122	21.4	●
200 x 260	162	146	136	52	M16	16	110	355	128900	1289	164	113	M16	16	110	295	78600	786	37700	192	118	22.4	●
220 x 285	162	146	136	52	M16	18	110	355	171800	1562	181	120	M16	18	110	295	105000	955	41400	195	126	26.6	●
240 x 305	162	146	136	52	M16	20	110	355	208000	1733	184	125	M16	20	110	295	128000	1067	45200	198	130	28.7	●
260 x 325	166	150	134	55	M16	21	110	355	237000	1823	169	117	M16	21	110	295	142000	1092	51000	187	123	31.2	●
280 x 355	197	177	165	66	M20	18	130	690	340000	2429	174	119	M20	18	130	580	208000	1486	81300	192	125	46.8	●
300 x 375	197	177	165	66	M20	20	130	690	405000	2700	181	125	M20	20	130	580	252000	1680	87100	198	130	69.7	●
320 x 405	197	177	165	66	M20	21	130	690	453000	2831	178	121	M20	21	130	580	280000	1750	92900	196	127	60.5	●
340 x 425	197	177	165	66	M20	22	130	690	504900	2970	176	121	M20	22	130	580	311000	1829	98700	193	127	63.9	●
360 x 455	224	203	190	76	M22	21	150	930	626000	3478	169	115	M22	21	150	780	381000	2117	138500	189	121	86.8	●
380 x 475	224	203	190	76	M22	22	150	930	692000	3642	167	115	M22	22	150	780	420000	2211	146000	188	122	91.0	●
400 x 495	224	203	190	76	M22	24	150	930	795000	3975	173	121	M22	24	150	780	489000	2445	154000	194	127	95.3	●
420 x 515	224	203	190	76	M22	24	150	930	835000	3976	165	116	M22	24	150	780	505000	2405	161500	186	123	100	●
440 x 535	224	203	190	76	M22	24	150	930	875000	3977	158	112	M22	24	150	780	517000	2350	169000	178	120	105	●
460 x 555	224	203	190	76	M22	24	150	930	914000	3974	151	108	M22	24	150	780	530000	2304	177000	172	117	109	●
480 x 575	224	203	190	76	M22	28	150	930	1113000	4638	169	121	M22	28	150	780	678000	2825	184500	189	128	114	●
500 x 595	224	203	190	76	M22	28	150	930	1160000	4640	162	117	M22	28	150	780	692000	2768	192000	182	125	119	●
520 x 615	224	203	190	76	M22	30	150	930	1292000	4969	167	122	M22	30	150	780	780000	3000	200000	186	129	122.5	●
540 x 635	224	203	190	76	M22	30	150	930	1342000	4970	161	118	M22	30	150	780	799000	2959	207500	180	126	128	●
560 x 655	224	203	190	76	M22	32	150	930	1484000	5300	165	122	M22	32	150	780	893000	3189	215500	184	129	131	●
580 x 675	224	203	190	76	M22	32	150	930	1537000	5300	159	118	M22	32	150	780	912000	3145	223000	179	127	136	●
600 x 695	224	203	190	76	M22	33	150	930	1640000	5467	159	118	M22	33	150	780	972000	3240	231000	179	127	139	●

● Sizes of clamping elements available from stock.

¹⁾ External ring from size 400 x 495 without slot.

²⁾ These are the maximum screw tightening torques. They can be reduced by a maximum of 40 % of the above-mentioned figures with T, F_{ax}, P_W and P_N decreasing proportionately.

CLAMPEX®

Clamping nuts

KTR Precision joints

Clamping sets

CLAMPEX® KTR 603

Clamping elements

Three-part external clamping set for applications on hollow shafts

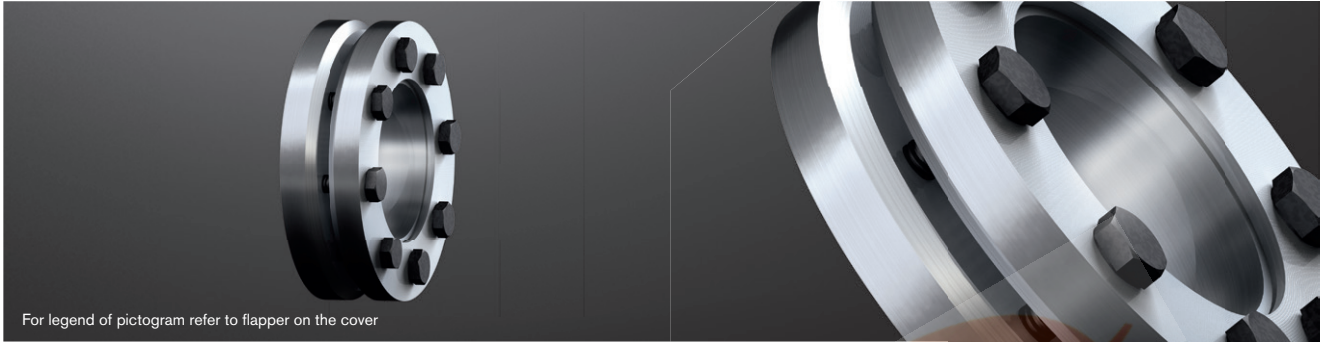

For legend of pictogram refer to flapper on the cover

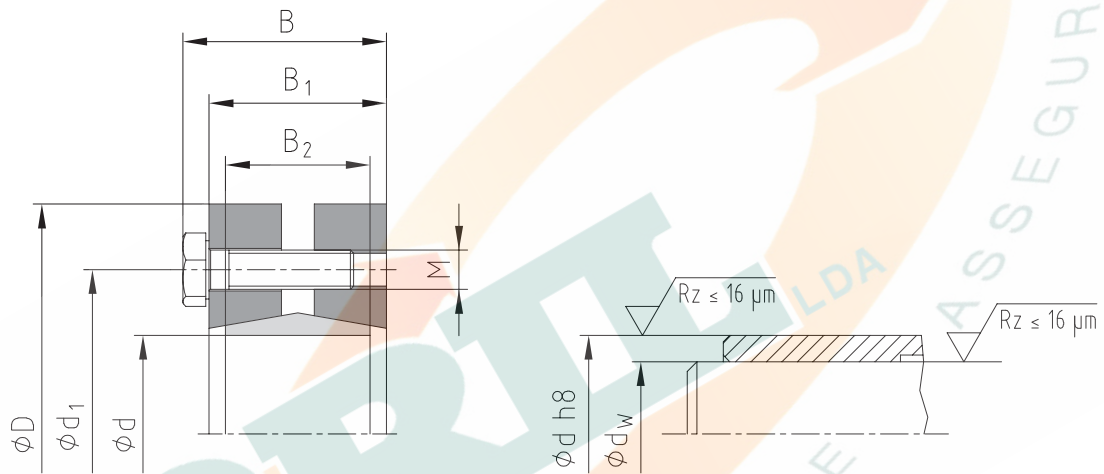

Tolerances for d_w

- For d_w from 10 to 30 mm **H6 / j6**
- For d_w from 31 to 50 mm **H6 / h6**
- For d_w from 51 to 80 mm **H6 / g6**
- For d_w from 81 to 500 mm **H7 / g6**

Example of application of hub type

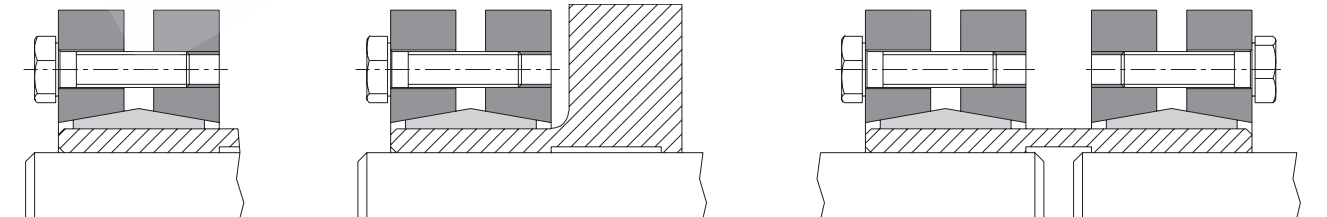

Ordering example:	KTR 603	44	x	80
	Series	Size of internal diameter d		Size of external diameter D

CLAMPEX® – KTR 603

d x D [mm]	Shaft diameter d _w [mm]	Transmittable torque or axial force		Dimensions [mm]				Clamping screws DIN EN ISO 4014 - 10.9 μ _{total} =0.10				Surface pressure of clamping element/hollow shaft P _H [N/mm ²]	Weight [-kg]	Stock programme	
		T [Nm]	F _{ax} [kN]	B	B ₁	B ₂	d ₁	M	Length	z = number	T _A [Nm]				
14 x 38	10	28	6												
	11	38	7	14.5	11	9	24	M5	10	4	3.5	388	0.1	●	
	12	50	8												
16 x 41	12	50	8												
	13	70	11	18.5	15	11	26	M5	14	5	4	310	0.2	●	
	14	90	13												
24 x 50	19	180	19												
	20	210	21	22.5	19	14	36	M5	18	6	5	286	0.2	●	
	21	250	24												
30 x 60	24	310	26												
	25	340	27	24.5	21	16	44	M5	18	6	6	233	0.3	●	
	26	380	29												
36 x 72	28	460	33												
	30	590	39	27	23	18	52	M6	20	5	12	307	0.4	●	
	31	630	41												
44 x 80	32	630	39												
	35	780	45	29	25	20	61	M6	22	7	12	317	0.6	●	
	36	860	48												
50 x 90	38	940	49												
	40	1100	55	31	27	22	70	M6	22	8	12	289	0.8	●	
	42	1300	62												
55 x 100	42	1200	57												
	45	1500	67	34	30	23	75	M6	25	8	12	252	1.1	●	
	48	1900	79												
62 x 110	48	1800	75												
	50	2200	88	34	30	23	86	M6	25	10	12	279	1.3	●	
	52	2400	92												
68 x 115	50	2000	80												
	55	2500	91	34	30	23	86	M6	25	10	12	255	1.4	●	
	60	3100	103												
75 x 138	55	2500	91												
	60	3200	107	37.5	32	25	100	M8	30	7	30	273	1.8	●	
	65	3900	120												
80 x 145	60	3200	107												
	65	3900	120	37.5	32	25	100	M8	30	7	30	256	2.6	●	
	70	4600	131												
85 x 155	65	4800	148												
	70	6100	174	44.5	39	30	114	M8	35	10	30	285	3.9	●	
	75	7400	197												
90 x 155	65	4700	145												
	70	6000	171	44.5	39	30	114	M8	35	10	30	217	3.8	●	
	75	7200	192												
100 x 170	70	6900	197												
	75	7500	200	49.5	44	34	124	M8	35	12	30	227	4.7	●	
	80	9000	225												
110 x 185	75	7200	192												
	80	9000	225	56.5	50	39	136	M10	40	9	59	215	6.0	●	
	85	11000	259												
115 x 188	80	8500	213												
	85	10000	235	56.5	50	39	141	M10	40	9	59	209	5.0	●	
	90	12000	267												
120 x 215	80	10500	263												
	85	13200	311	58.5	52	42	160	M10	40	12	59	271	5.9	●	
	90	14400	320												
125 x 215	85	11000	259												
	90	13000	289	58.5	52	42	160	M10	40	12	59	222	8.5	●	
	95	15000	316												
130 x 215	90	13700	304												
	95	15800	333	58.5	52	42	160	M10	40	12	59	227	9.0	●	
	100	18200	364												
140 x 230	95	15000	316												
	100	17000	340	67.5	60	46	175	M12	45	10	100	209	11	●	
	105	20000	381												

● Sizes of clamping elements available from stock.
Other sizes on request.

CLAMPEX®

Clamping nuts

KTR Precision joints

Clamping sets

CLAMPEX® KTR 603

Clamping elements

Three-part external clamping set for applications on hollow shafts

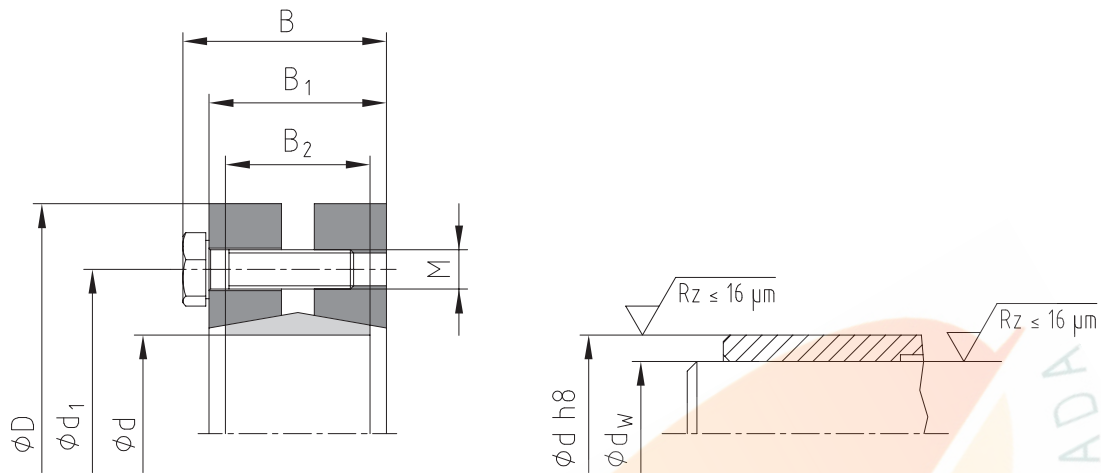

CLAMPEX® – KTR 603														
d x D [mm]	Shaft diameter d _w [mm]	Transmittable torque or axial force		Dimensions [mm]				Clamping screws DIN EN ISO 4014 - 10.9 μ _{total} =0.10				Surface pressure of clamping element/hollow shaft	Weight [~kg]	Stock programme
		T [Nm]	F _{ax} [kN]	B	B ₁	B ₂	d ₁	M	Length	z = number	T _A [Nm]	P _H [N/mm ²]		
155 x 265	105	20000	381	71.5	64	50	192	M12	50	12	100	212	15	
	110	23000	418											
	115	26000	452											
160 x 265	110	22500	409	71.5	64	50	192	M12	50	12	100	204	14	
	115	25500	443											
	120	28600	477											
165 x 290	115	36000	626	81	71	56	210	M16	60	8	250	269	24	
	120	39000	650											
	125	44000	704											
170 x 290	120	31700	528	81	71	56	210	M16	60	8	250	216	24	
	125	35800	573											
	130	40000	615											
175 x 300	125	40000	640	81	71	56	220	M16	60	8	250	253	16	
	130	44000	677											
	135	49000	726											
180 x 300	130	36800	566	81	71	56	220	M16	60	8	250	211	16	
	135	42000	622											
	140	46000	657											
185 x 330	135	55000	815	96	86	71	236	M16	65	10	250	231	35	
	140	60000	857											
	145	65000	897											
190 x 330	140	53300	761	96	86	71	236	M16	65	10	250	201	35	
	145	58500	807											
	150	63500	847											
195 x 350	140	66000	943	96	86	71	246	M16	65	12	250	259	38	
	150	76000	1013											
	155	82000	1058											
200 x 350	150	73700	983	96	86	71	246	M16	65	12	250	240	41	
	155	79800	1030											
	160	85800	1073											
220 x 370	160	95000	1188	114	104	88	270	M16	80	15	250	216	54	
	165	102000	1236											
	170	110000	1294											
240 x 405	170	120000	1412	121.5	109	92	295	M20	80	12	490	239	67	
	180	140000	1556											
	190	160000	1684											
250 x 405	180	160000	1778	120.5	108	92	295	M20	85	14	490	263	64	
	190	180000	1895											
	200	200000	2000											
260 x 430	190	165000	1737	132.5	120	103	321	M20	90	14	490	225	82	
	200	185000	1850											
	210	204000	1943											

● Sizes of clamping elements available from stock.
Other sizes on request.

CLAMPEX® – KTR 603														
d x D [mm]	Shaft diameter d _w [mm]	Transmittable torque or axial force		Dimensions [mm]				Clamping screws DIN EN ISO 4014 - 10.9 μ _{total} =0.10				Surface pressure of clamping element/hollow shaft P _H [N/mm ²]	Weight [-kg]	Stock programme
		T [Nm]	F _{ax} [kN]	B	B ₁	B ₂	d ₁	M	Length	z = number	T _A [Nm]			
280 x 460	210	216000	2057											
	220	245000	2227	146.5	134	114	346	M20	100	16	490	217	102	
	230	270000	2348											
300 x 485	230	274000	2383											
	240	296000	2467	154.5	142	122	364	M20	100	18	490	209	118	
	245	316000	2580											
320 x 520	240	311000	2592											
	250	340000	2720	154.5	142	122	386	M20	100	20	490	219	131	
	260	375000	2885											
330 x 520	250	352000	2816											
	260	385000	2962	154.5	142	122	386	M20	100	22	490	224	126.1	
	270	420000	3111											
340 x 570	250	389000	3112											
	260	422000	3246	168.5	156	134	408	M20	110	24	490	227	186	
	270	459000	3400											
350 x 580	270	443000	3281											
	280	480000	3429	174.5	162	140	432	M20	110	24	490	212	195	
	285	500000	3509											
360 x 590	280	462000	3300											
	290	500000	3448	174.5	162	140	432	M20	110	24	490	204	204	
	300	530000	3533											
380 x 645	290	570000	3931											
	300	610000	4067	183	168	144	458	M24	120	20	840	224	239	
	310	660000	4258											
390 x 660	300	625000	4167											
	310	670000	4323	183	168	144	468	M24	120	21	840	229	260	
	320	720000	4500											
400 x 680	315	671000	4260											
	320	695000	4344	183	168	144	480	M24	120	21	840	222	280	
	330	745000	4515											
420 x 690	330	782000	4739											
	340	841000	4947	203	188	164	504	M24	130	24	840	211	316	
	350	902000	5154											
440 x 750	340	805000	4735											
	350	861000	4920	217	202	177	527	M24	140	24	840	190	408	
	360	920000	5111											
460 x 770	360	1000000	5556											
	370	1073000	5800	217	202	177	547	M24	140	28	840	210	420	
	380	1141000	6005											
480 x 800	380	1175000	6184											
	390	1250000	6410	228	213	188	570	M24	140	30	840	206	505	
	400	1312000	6560											
500 x 850	400	1314000	6570											
	410	1382000	6741	230	213	188	590	M27	150	24	1250	205	575	
	420	1460000	6952											

● Sizes of clamping elements available from stock.
Other sizes on request.

CLAMPEX® KTR 620

Clamping elements

Two-part external clamping set for applications on hollow shafts

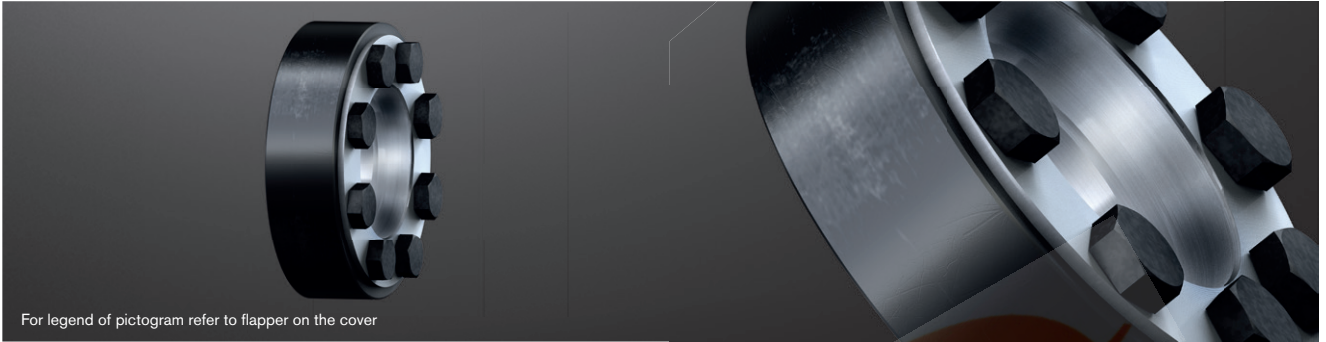

For legend of pictogram refer to flapper on the cover

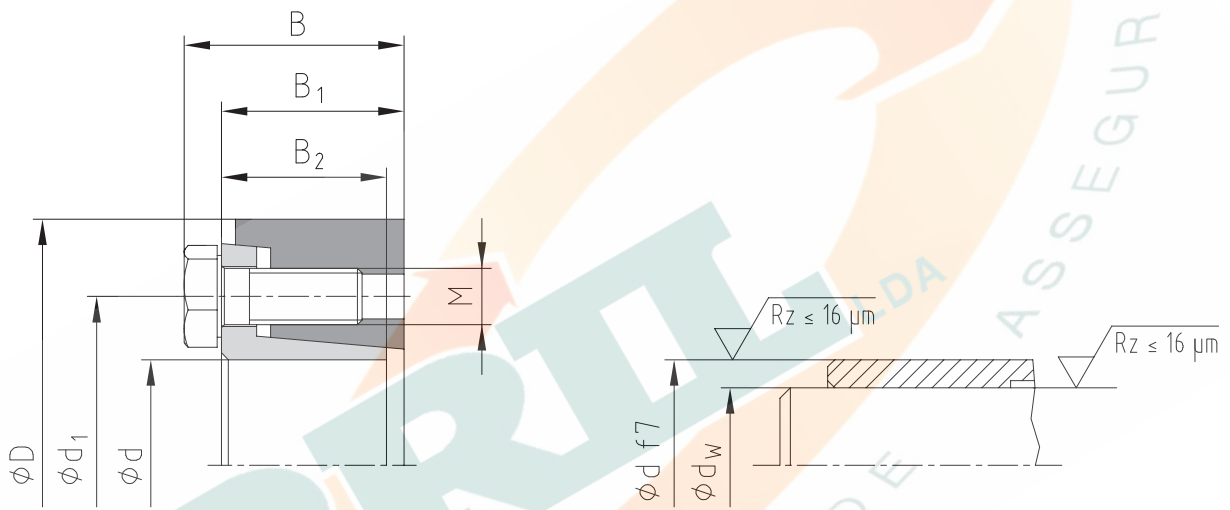

Tolerances for d_w

- $d_w \leq \varnothing 160 = h6/H7$
- $d_w > \varnothing 160 = g6/H7$

Example of application of hub type

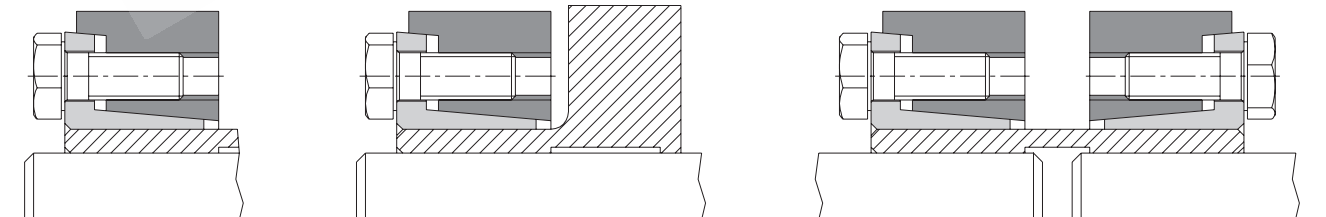

Ordering example:	KTR 620	55	x	100
	Series	Size of internal diameter d		Size of external diameter D

CLAMPEX® – KTR 620

d x D [mm]	Shaft diameter d _w [mm]	Transmittable torque or axial force		Dimensions [mm]				Clamping screws DIN EN ISO 4017 - 12.9 ¹⁾ μ _{total} =0.10				Surface pressure of clamping element/hollow shaft P _H [N/mm ²]	Weight [-kg]	Stock programme
		T [Nm]	F _{ax} [kN]	B	B ₁	B ₂	d ₁	M	Length	z = number	T _A [Nm]			
16 x 41	13	70	11	19.5	15.3	13.5	28	M6	12	3	13	254	0.1	
	14	90	13											
18 x 44	15	80	11	19.5	15.3	13.5	30	M6	12	4	13	222	0.1	
	16	110	14											
20 x 47	17	150	18	19.5	15.3	13.5	32	M6	12	4	13	274	0.1	●
	18	175	19											
24 x 50	19	165	17	22	18.22	16	36	M6	16	5	13	243	0.2	●
	20	215	22											
26 x 51.5	22	280	25	22	18.05	16	38	M6	16	5	13	238	0.2	
	20	200	20											
30 x 60	24	370	31	24	20.26	18	44	M6	16	6	13	255	0.3	●
	25	420	34											
36 x 72	26	465	36	27.5	22.1	20	52	M8	20	5	30	250	0.5	●
	27	480	36											
38 x 72	30	650	43	27.5	22.1	20	54	M8	20	5	30	240	0.5	●
	33	765	46											
40 x 80	34	830	49	29.5	24.22	22	61	M8	20	6	30	209	0.6	●
	35	770	44											
44 x 80	37	880	48	29.5	24.22	22	61	M8	20	6	30	192	0.6	●
	38	1130	59											
50 x 90	40	1260	63	31.5	26.1	23.5	68	M8	20	8	30	212	0.8	●
	42	1400	67											
55 x 100	42	1300	62	34.5	29	26	72	M8	20	8	30	195	1.1	●
	45	1600	71											
60 x 110	48	1900	79	34.5	29.25	26	80	M8	20	9	30	191	1.3	●
	48	1700	71											
62 x 110	50	1950	78	34.5	29.25	26	80	M8	20	9	30	189	1.3	●
	52	2160	83											
68 x 115	50	1900	76	35	29.4	26	86	M8	20	9	30	206	1.3	●
	55	2500	91											
75 x 138	60	3150	105	37.5	30.7	27	100	M10	25	10	60	211	2.3	●
	55	2700	98											
80 x 141	60	3400	113	37.5	31.1	27	104	M10	25	10	60	215	2.3	●
	65	4100	126											
85 x 155	65	5500	169	44.5	38.2	34	114	M10	25	11	60	216	3.2	
	70	6400	183											
90 x 155	75	7300	195	44.5	38.2	34	114	M10	25	11	60	223	3.2	●
	65	5500	169											
95 x 170	70	6200	177	50	43.45	39	124	M10	30	14	60	182	4.3	
	75	7400	197											
100 x 170	80	8600	215	50	43.45	39	124	M10	30	14	60	176	4.3	●
	70	6200	177											
105 x 185	75	7400	197	56.5	49.1	43.5	136	M12	35	12	100	208	5.8	
	80	8600	215											
110 x 185	80	10500	263	56.5	49.1	43.5	136	M12	35	12	100	202	5.8	●
	85	11800	278											
115 x 197	90	13700	304	60.5	53	48	147	M12	35	14	100	193	6.9	
	80	10500	263											
120 x 197	85	12500	294	60.5	53	48	147	M12	35	14	100	189	6.9	
	90	14100	313											
	95	16000	337											
	85	12500	294											
	90	14100	313											
	95	16000	337											

● Sizes of clamping elements available from stock.
¹⁾ DIN EN ISO 4017-10.9 for size 16 x 41 to 20 x 47

CLAMPEX® KTR 620

Clamping elements

Two-part external clamping set for applications on hollow shafts

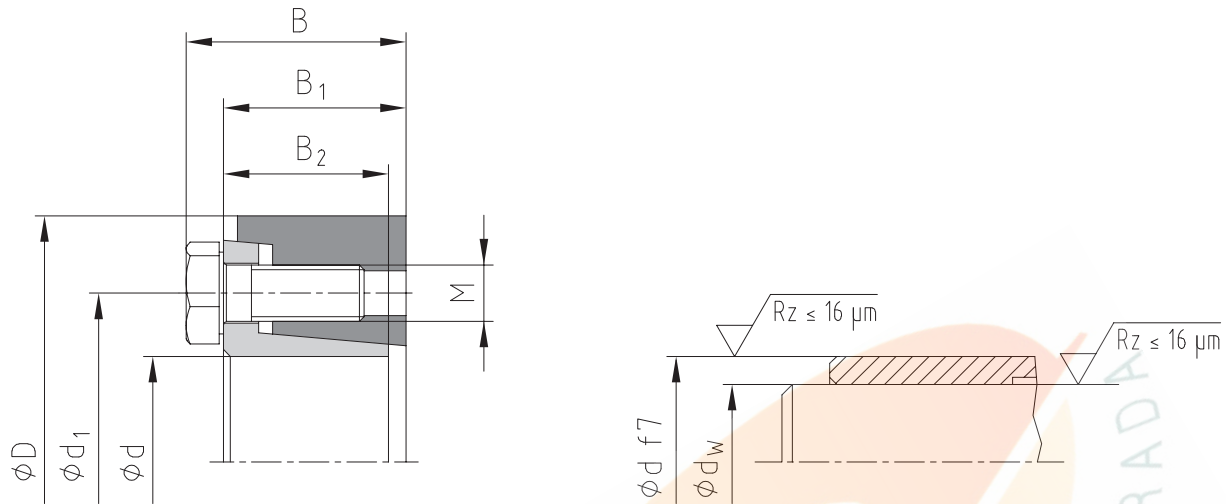

CLAMPEX® – KTR 620

d x D [mm]	Shaft diameter d _w [mm]	Transmittable torque or axial force		Dimensions [mm]				Clamping screws DIN EN ISO 4017 - 12.9 μ _{total} =0.10				Surface pressure of clamping element/hollow shaft		Weight [-kg]	Stock programme
		T [Nm]	F _{ax} [kN]	B	B ₁	B ₂	d ₁	M	Length	z = number	T _A [Nm]	P _H [N/mm ²]			
125 x 215	90	14500	322	61	53.4	48	158	M12	35	14	100	196	8.7	●	
	95	16600	349												
	100	18800	376												
130 x 215	95	17000	358	61	53.4	48	158	M12	35	14	100	187	9.4		
	100	18400	368												
	110	22000	400												
130 x 230	95	18400	387	66.5	57.5	51	165	M14	40	12	160	213	10.8	●	
	100	20800	416												
	110	26200	476												
135x 230	95	18400	387	66.5	57.5	51	165	M14	40	12	160	209	10.8		
	100	20800	416												
	110	26200	476												
140 x 230	100	19900	398	67	57.8	51	172	M14	40	12	160	207	10.3		
	105	22200	423												
	115	27800	483												
150 x 263	110	27000	491	71	62.2	55	186	M14	40	14	160	202	15.2		
	120	32000	533												
	125	36200	579												
155 x 263	110	27000	491	71	62.2	55	186	M14	40	14	160	199	15.2		
	120	32000	533												
	125	36200	579												
160 x 290	120	39000	650	78.5	68.5	61	198	M16	45	12	250	215	21.5		
	130	48000	738												
	135	51000	756												
165 x 290	120	39000	650	78.5	68.5	61	198	M16	45	12	250	212	21.5		
	130	48000	738												
	135	51000	756												
170 x 300	130	46500	715	79	68.9	61	208	M16	50	14	250	212	22.5		
	140	53000	757												
	145	59000	814												
175 x 300	130	46500	715	79	68.9	61	208	M16	50	14	250	209	22.5	●	
	140	53000	757												
	145	59000	814												
180 x 320	140	66000	943	95	85	77.5	222	M16	50	16	250	210	32.7		
	150	76000	1013												
	155	83000	1071												
185 x 320	140	66000	943	95	85	77.5	222	M16	50	16	250	207	32.7		
	150	76000	1013												
	155	83000	1071												
190 x 340	150	82000	1093	98	87.7	77.5	238	M16	50	16	250	225	36.3		
	160	91000	1138												
	165	102000	1236												
195 x 340	150	82000	1093	98	87.7	77.5	238	M16	50	16	250	222	36.3		
	160	91000	1138												
	165	102000	1236												
200 x 340	150	82000	1093	98	87.7	77.5	238	M16	50	16	250	219	36.3		
	160	91000	1138												
	165	102000	1236												

● Sizes of clamping elements available from stock.

CLAMPEX® – KTR 620

d x D [mm]	Shaft diameter d _w [mm]	Transmittable torque or axial force		Dimensions [mm]				Clamping screws DIN EN ISO 4017 - 12.9 ²⁾ H _{total} =0.10				Surface pressure of clamping element/hollow shaft	Weight [-kg]	Stock programme
		T [Nm]	F _{ax} [kN]	B	B ₁	B ₂	d ₁	M	Length	z = number	T _A [Nm]	P _H [N/mm ²]		
220 x 370	160	105000	1313	120	107.55	96.5	268	M20	60	15	480	205	53	
	170	122000	1435											
	180	138000	1533											
240 x 405	170	125000	1471	123.5	111.1	98	288	M20	60	16	480	214	66	
	180	145000	1611											
	200	182000	1820											
260 x 430	190	165000	1737	138	125.3	110.5	312	M20	60	16	480	202	82	
	200	190000	1900											
	220	238000	2164											
280 x 460	210	220000	2095	152.5	140	121	334	M20	60	18	480	193	103	
	220	245000	2227											
	240	300000	2500											
300 x 485	220	297000	2700	159	139.8	124	360	M24	70	16	840	205	120	
	230	330000	2870											
	250	399000	3192											
320 x 520	240	331000	2758	160.5	141.6	124	380	M24	70	18	840	190	138	
	250	365000	2920											
	270	437000	3237											
340 x 570	250	429000	3432	177.5	158.4	139	402	M24	70	18	840	195	189	
	260	469000	3608											
	280	556000	3971											
360 x 590	270	545000	4037	182	163	143	424	M24	70	20	840	216	207	
	280	592000	4229											
	290	694000	4786											
390 x 650	290	704000	4855	191	169.2	148	454	M27	70	18	1250	216	249	
	300	760000	5067											
	320	879000	5494											
420 x 670	320	827000	5169	208.4	186.4	166	486	M27	70	20	1250	184	285	
	330	876000	5309											
	350	1000000	5714											
440 x 710	340	1117000	6571	220	198	179	506	M27	70	21	1250	222	343	
	350	1190000	6800											
	370	1345000	7270											
460 x 750	360	1306000	7256	223	201	179	534	M27	70	21	1250	230	387	
	370	1386000	7492											
	390	1554000	7969											
470 x 705	370	950000	5135	241.6	219.6	200	538	M27	70	21	1250	151	340	
	380	1000000	5263											
	400	1150000	5750											
480 x 770	380	1557000	8195	247	223	201	552	M30	100	21	1650	223	449	
	390	1648000	8451											
	410	1818000	8868											
500 x 820	400	1653000	8265	241	217	198	572	M30	100	24	1650	214	515	
	410	1725000	8415											
	430	1915000	8907											
530 x 850	430	2048000	9526	262.3	238.3	216	606.5	M30	100	24	1650	208	585	
	440	2154000	9791											
	460	2374000	10322											
560 x 885	450	2306000	10249	266	242	220	632	M30	100	24	1650	212	636	
	460	2419000	10517											
	480	2654000	11058											
590 x 950	470	2735000	11638	281.5	257.5	236	664	M30	100	28	1650	211	805	
	480	2863000	11929											
	500	3128000	12512											
620 x 960	500	3150000	12600	307	283	258	706	M30	100	28	1650	201	853	
	520	3396000	13062											
	540	3689000	13663											
660 x 1020	530	3636000	13721	319	293	267	748	M33	130	28	2250	199	993	
	550	3942000	14335											
	570	4261000	14951											
700 x 1085	560	4189000	14961	318.5	292.5	263	788	M33	130	28	2250	187	1112	
	580	4520000	15586											
	600	4863000	16210											
750 x 1100	600	5281000	17603	346	320	280	850	M33	130	32	2250	202	1111	
	620	5672000	18297											
	650	6287000	19345											
800 x 1230	640	6091000	19034	359	333	296	900	M33	130	32	2250	202	1589	
	660	6511000	19730											
	700	7394000	21126											

● Sizes of clamping elements available from stock.
²⁾ DIN EN ISO 4014-12.9 for size 660 x 1020 to 800 x 1230

CLAMPEX® KTR 700

Clamping elements

Rigid shaft coupling to connect two shaft ends

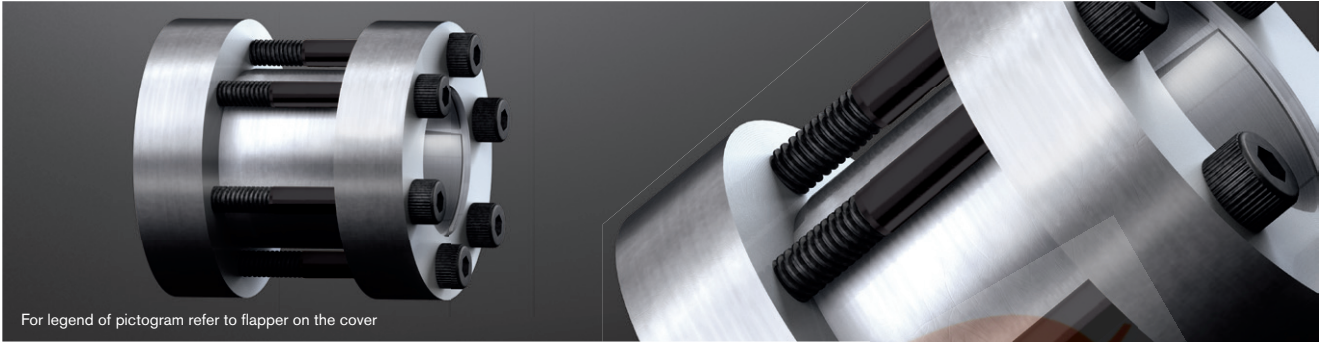

For legend of pictogram refer to flapper on the cover

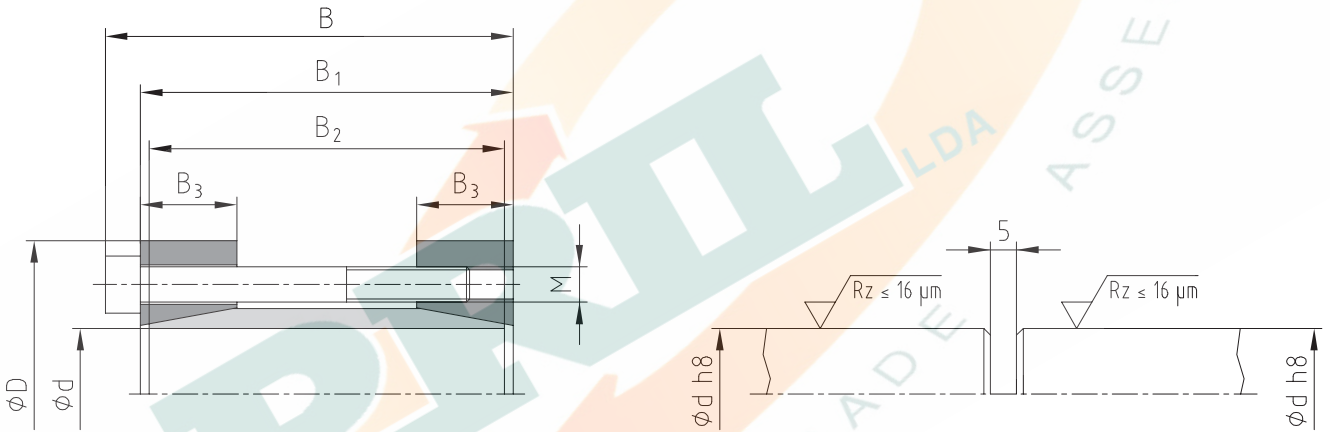
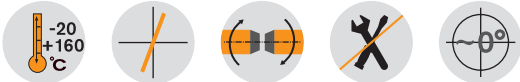

Example of application

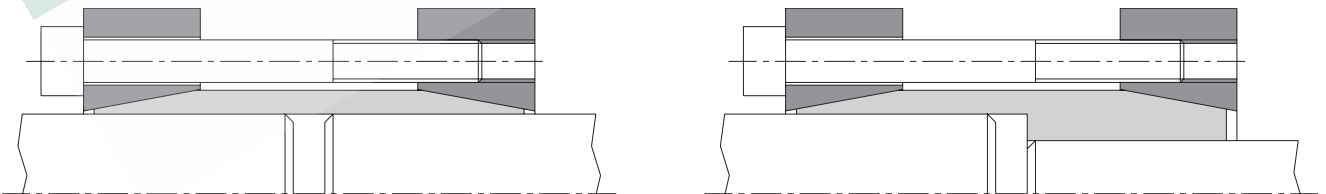

Type on request

Ordering example:	KTR 700	35	x	75
	Series	Size of internal diameter d		Size of external diameter D

CLAMPEX® – KTR 700														
d x D [mm]	Dimensions [mm]				Clamping screws DIN EN ISO 4762 - 12.9 $\mu_{total}=0.14$				Transmittable torque or axial force			Surface pressure of clamping element/ shaft	Weight [~kg]	Stock pro- gramme
	B	B ₁	B ₂	B ₃	M	Length	z = number	T _A [Nm]	T [Nm]	F _{ax} [kN]	P _{VV} [N/mm ²]			
10 x 35	42	38	36	15	M4	30	6	5.5	62	12	219	0.2		
11 x 35	42	38	36	15	M4	30	6	5.5	66	12	193	0.2		
12 x 35	42	38	36	15	M4	30	6	5.5	72	12	177	0.2		
14 x 35	42	38	36	15	M4	30	6	5	76	11	137	0.2		
15 x 45	56	50	47	15	M6	45	4	17	160	21	252	0.4		
16 x 45	56	50	47	15	M6	45	4	17	170	21	235	0.4		
17 x 45	56	50	47	15	M6	45	4	17	180	21	220	0.4	●	
18 x 50	56	50	47	15	M6	45	4	17	190	21	207	0.5		
19 x 50	56	50	47	15	M6	45	4	17	200	21	196	0.4		
20 x 50	56	50	47	15	M6	45	4	17	220	22	195	0.4	●	
22 x 55	66	60	57	18	M6	55	6	17	360	33	219	0.5		
24 x 55	66	60	57	18	M6	55	6	17	390	33	200	0.6		
25 x 55	66	60	57	18	M6	55	6	17	400	32	189	0.6	●	
28 x 60	66	60	57	18	M6	55	6	17	390	28	147	0.8		
30 x 60	66	60	57	18	M6	55	6	17	420	28	138	0.7	●	
32 x 75	83	75	72	20	M8	70	4	41	610	38	158	0.1		
35 x 75	83	75	72	20	M8	70	4	41	670	38	145	1.3	●	
38 x 75	83	75	72	20	M8	70	4	41	730	38	134	1.2		
40 x 75	83	75	72	20	M8	70	4	41	760	38	126	1.2	●	
42 x 85	93	85	81	22	M8	80	6	41	1170	56	160	1.8		
45 x 85	93	85	81	22	M8	80	6	41	1260	56	150	1.7		
48 x 90	93	85	81	22	M8	80	6	41	1360	57	142	1.9		
50 x 90	93	85	81	22	M8	80	6	41	1400	56	135	1.8	●	
55 x 95	93	85	81	22	M8	80	8	41	2000	73	159	2.0		
60 x 100	93	85	81	22	M8	80	8	41	2260	75	151	2.2	●	
65 x 105	93	85	81	22	M8	80	8	41	2500	77	143	2.6		
70 x 115	110	100	96	35	M10	80	8	83	3300	94	102	4.1		
75 x 120	110	100	96	35	M10	80	8	83	3500	93	94	4.3		
80 x 125	110	100	96	35	M10	80	7	75	3900	98	92	4.5		
90 x 136	110	100	96	35	M10	80	8	75	5100	113	95	5.2		
100 x 158	132	120	116	40	M12	100	8	130	8350	167	111	6.0		

● Sizes of clamping elements available from stock.

KTR Clamping nuts

Large screw connections for easy and quick assembly

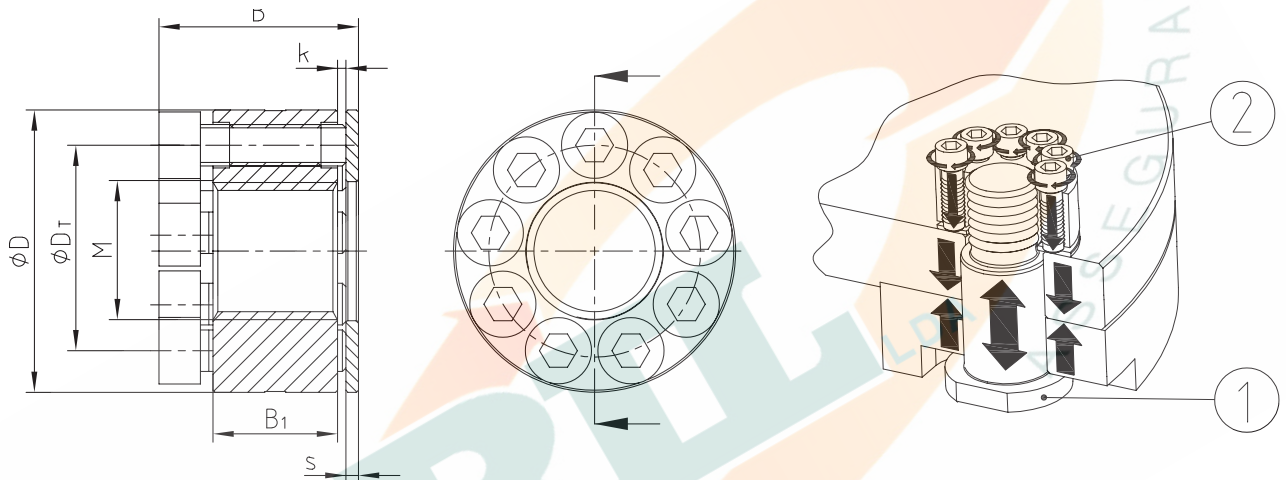

KTR Clamping nuts													
Size	Dimensions [mm]						Pressure screw pos. 2		Property class 8.8, screw pos. 1		Property class 10.9, screw pos. 1		
	D	D _T	B	B ₁	s	k	DIN EN ISO 4762	z = number	Tightening torque* [Nm]	Preload force [N]	Tightening torque* [Nm]	Preload force [N]	
M24 x 3.0	52	39	36.0	20	3.0	1 - 2	M8	8	21	174000	30	249000	
M27 x 3.0	57	42	41.0	25	3.0	1 - 2	M8	9	24	224000	30	280000	
M30 x 3.5	65	48	43.0	25	3.0	1 - 2	M10	8	41	274000	60	401000	
M33 x 3.5	68	51	48.0	30	3.0	1 - 2	M10	9	45	338000	60	451000	
M36 x 4.0	80	58	50.0	30	3.0	1 - 2	M12	8	71	396000	105	586000	
M42 x 4.5	86	64	55.0	35	3.0	1 - 2	M12	10	78	544000	105	732000	
M48 x 5.0	90	72	60.0	40	3.0	1 - 2	M12	11	94	721000	105	806000	
M52 x 5.0	100	79	66.5	42	4.5	1 - 2	M12	13	95	862000	105	952000	
M56 x 5.5	108	83	75.5	45	4.5	1 - 2	M16	9	210	1001000	250	1192000	
M60 x 5.5	112	86	80.5	48	4.5	1 - 2	M16	10	215	1139000	250	1325000	
M64 x 6.0	120	92	84.0	52	8.0	1 - 2	M16	11	225	1311000	250	1457000	
M72 x 6.0	142	107	98.0	58	8.0	1 - 2	M20	10	400	1696000	490	2077000	
M80 x 6.0	164	122	103.0	64	8.0	1 - 2	M20	12	420	2137000	490	2493000	

* each screw pos. 2

Ordering example:	KTR clamping nut	M33 x 3.5
	Description	Size

Used on 100 kNm test bench flanges

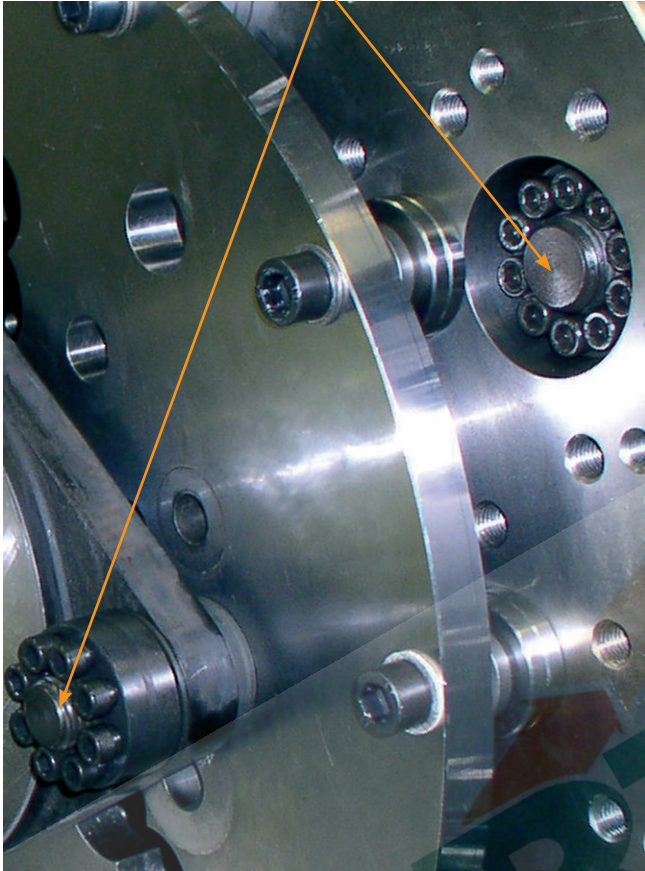

Used on couplings for wind turbines

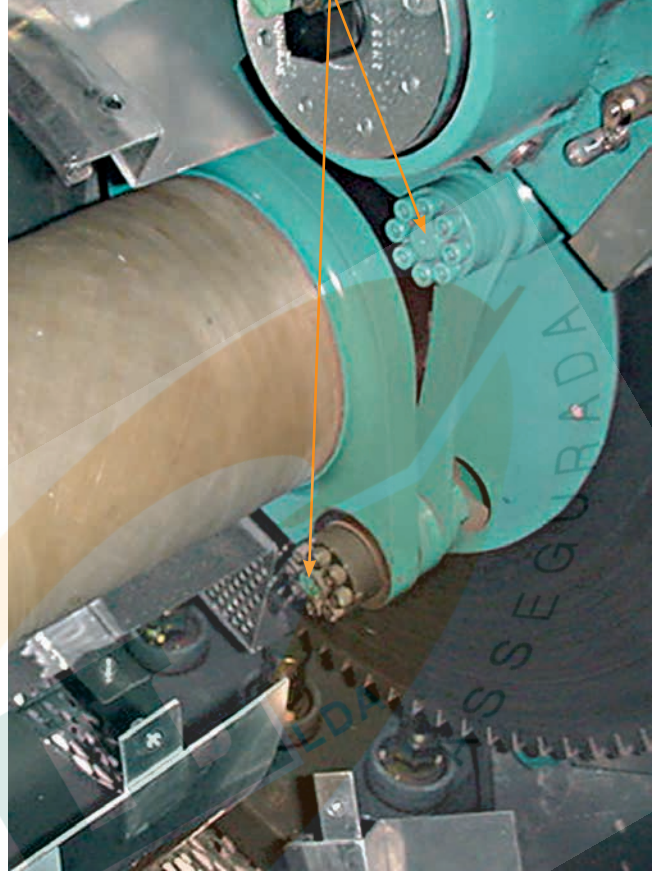

Available as a complete unit including
dowel screw

